

# Panasonic Omnivision VHS

## Operating Instructions

Video Cassette Recorder



MODEL PV-9405S

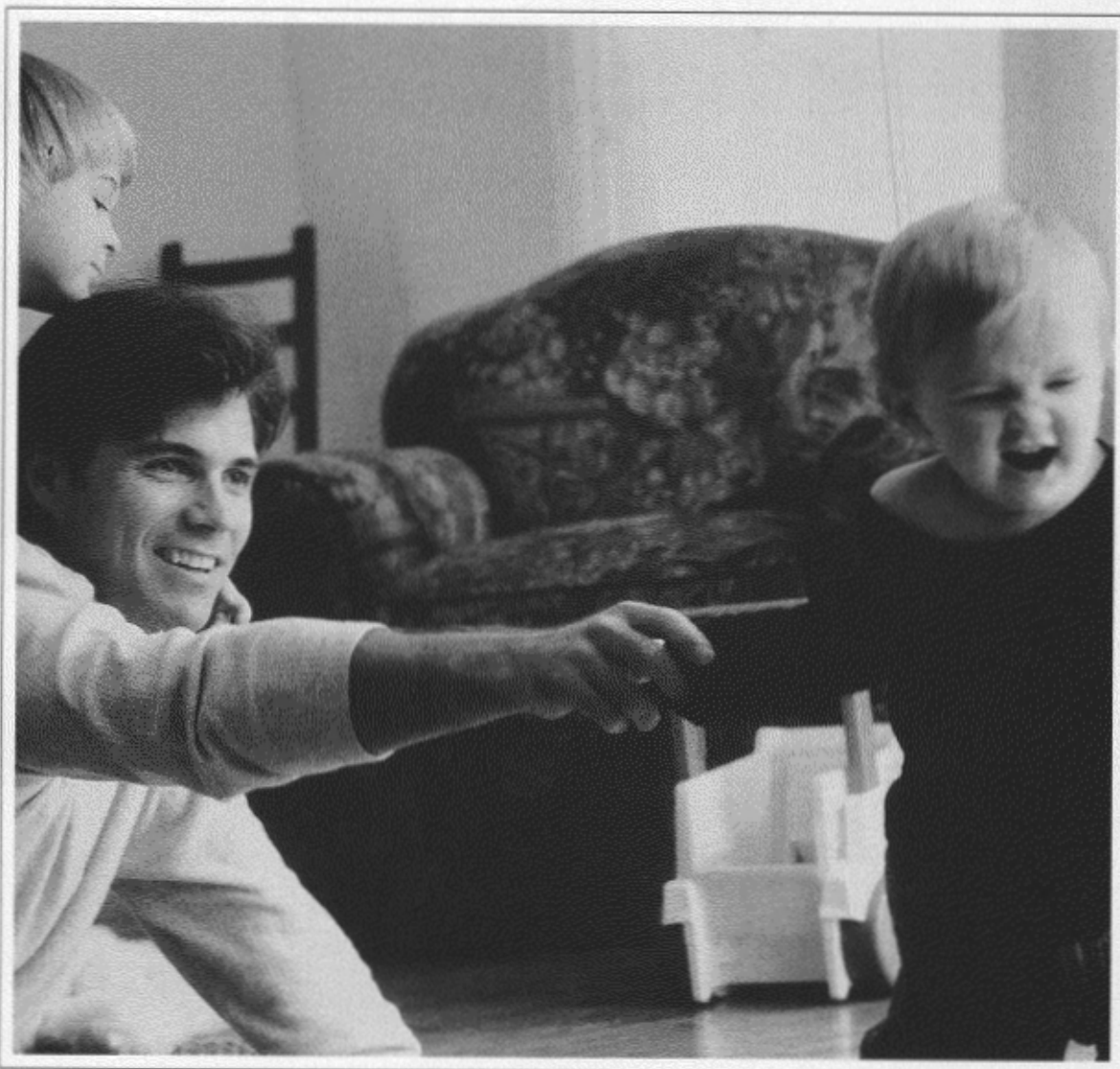

Basic Operation

Advanced Operation

For Your Information

Please read these instructions carefully before attempting to connect, operate or adjust this product. Please save this manual.

Spanish Quick Use Guide is included. (Guía para rápida consulta en español está incluida.)

Quick Use Guide is on the back cover.

As an ENERGY STAR® Partner, Matsushita Electric Corporation of America has determined that this product or product model meets the ENERGY STAR® guidelines for energy efficiency.



# Important Safeguards and Precautions

**FOR YOUR SAFETY, READ AND RETAIN ALL SAFETY AND OPERATING INSTRUCTIONS. HEED ALL WARNINGS IN THE MANUAL AND ON THE UNIT**

## INSTALLATION

### 1 POWER SOURCE CAUTION

Operate only from a power source indicated on the unit or in this manual. If necessary, have your Electric Utility Service Company or Video Products Dealer verify the power source in your home.

### 2 POLARIZED OR GROUNDING PLUG

As a safety feature, this Video product comes with either a polarized power cord plug (one blade is wider than the other), or a three-wire grounding type plug.

#### POLARIZED PLUG CAUTION:

This plug will only fit into an outlet one way. If you cannot fully insert the plug, try reversing it. If it still will not fit, have an electrician install the proper wall outlet. Do not defeat the safety feature by tampering with the plug.

#### GROUNDING PLUG CAUTION:

This plug will only fit into a three-hole grounding outlet. If necessary, have an electrician install the proper outlet. Do not defeat the safety feature by tampering with the plug.

### 3 POWER CORD

Make sure power cords are routed so that they are not likely to have anything rest on them, roll over them, or be in the way of walking traffic. If an extension cord is used, make sure it also has either a polarized or grounded plug and that the cords can be securely connected. Frayed cords, damaged plugs, and damaged or cracked wire insulation are hazardous and should be replaced by a qualified service technician. Overloaded outlets and extension cords are fire hazards and should be avoided.

### 4 DO NOT BLOCK VENTILATION HOLES

Ventilation openings in the cabinet release heat generated during operation. If they are blocked, heat build-up inside the unit can cause failures that may result in a fire hazard or heat damage to cassettes.

For protection, follow these rules:

- Never cover ventilation slots or the unit while in use, or operate the unit when placed on a bed, sofa, rug, or other soft surface.
- Avoid built-in installation, such as a book case or rack, unless proper ventilation is provided.

### 5 AVOID EXTREMELY HOT LOCATIONS OR SUDDEN TEMPERATURE CHANGES

Do not place the unit over or near any kind of heater or regulator, in direct sunlight, inside a closed vehicle, etc.. Do not move the unit suddenly between areas of extreme temperature variation. If the unit is suddenly moved from a cold place to a warm place, moisture may condense in the unit and on the tape.

### 6 TO AVOID PERSONAL INJURY

- Do not place unsecured equipment on a sloping surface.
- Do not place this unit on any support that is not firm, level, and adequately strong. The unit could fall causing serious injury to a child or adult and damage to the unit.
- An appliance and cart combination should be moved with care. Quick stops, excessive force, and uneven surfaces may cause the appliance and cart combination to overturn.
- Carefully follow all operating instructions and use the manufacturer's recommended accessories when operating this unit or connecting it to any other equipment.



## OUTDOOR ANTENNA INSTALLATION

### 1 SAFE ANTENNA AND CABLE CONNECTION

If an outside antenna or cable system is connected to the equipment, be sure the antenna or cable system is grounded so as to provide some protection against built up static charges and voltage surges.

Section 810 of the National Electrical Code, ANSI/NFPA 70 (in Canada, part 1 of the Canadian Electrical Code) provides information with respect to proper grounding of the mast and supporting structure, grounding of the lead-in wire to an antenna discharge unit, size of grounding conductors, location of antenna discharge unit, connection to grounding electrodes and requirements for the grounding electrode.

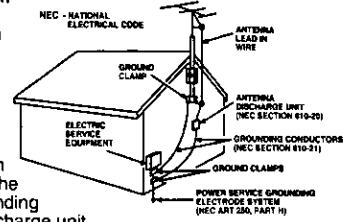

### 2 KEEP ANTENNA CLEAR OF HIGH VOLTAGE POWER LINES OR CIRCUITS

An outside antenna system should be located well away from power lines, electric light or power circuits and where it will never come into contact with these power sources if it should happen to fall. When installing an outside antenna, extreme care should be taken to avoid touching power lines, circuits or other power sources as this could be fatal. Because of the hazards involved, antenna installation should be left to a professional.

## USING THE VIDEO UNIT

If the unit has been in storage or moved to a new location, refer first to the INSTALLATION section of these safeguards.

### 1 KEEP THIS VIDEO UNIT AWAY FROM WATER OR MOISTURE OF ANY KIND.

2 IF EQUIPMENT IS EXPOSED TO RAIN, MOISTURE, OR STRONG IMPACT, unplug the unit and have it inspected by a qualified service technician before use.

### 3 DURING AN ELECTRICAL STORM

During a lightning storm, whether indoors or outdoors, or before leaving the unit unused for extended periods of time, disconnect all equipment from the power source as well as the antenna and cable system.

### 4 WHEN THE UNIT IS PLUGGED IN

- Never expose the unit to rain or water. DO NOT OPERATE if liquid has been spilled into the unit. Immediately unplug the unit, and have it inspected by a service technician. Fire and shock hazards can result from electrical shorts caused by liquid contact inside.
- Never drop or push any object through openings in the unit. Some internal parts carry hazardous voltages and contact can cause electric shock or fire hazard.
- Avoid placing the unit directly above or below your TV set as this may cause electrical interference. Keep all magnets away from electronic equipment.

### 5 USING ACCESSORIES

Use only accessories recommended by the manufacturer to avoid risk of fire, shock, or other hazards.

### 6 CLEANING THE UNIT

Unplug the unit. Then, use a clean, dry, chemically untreated cloth to gently remove dust or debris. DO NOT USE cleaning fluids, aerosols, or forced air that could over-spray, or seep into the unit and cause electrical shock. Any substance such as wax, adhesive tape, etc. may mar the cabinet surface. Exposure to greasy, humid, or dusty areas may adversely affect internal parts.

## SERVICE

### 1 DO NOT SERVICE THIS PRODUCT YOURSELF

If, after carefully following the detailed operating instructions, this Video product does not operate properly, do not attempt to open or remove covers, or make any adjustments not described in the manual. Unplug the unit and contact a qualified service technician.

### 2 IF REPLACEMENT PARTS ARE REQUIRED

Make sure the service technician uses only parts specified by the manufacturer, or those having the same safety characteristics as the original parts. The use of unauthorized substitutes may result in fire, electric shock, or other hazards.

### 3 HAVE THE SERVICE TECHNICIAN PERFORM A SAFETY CHECK

After any service or repairs to the unit, request the service technician to conduct a thorough safety check as described in the manufacturer's service literature to insure that the video unit is in safe operating condition.

## Safety Precautions

**Warning:** To prevent fire or shock hazard, do not expose this equipment to rain or moisture.

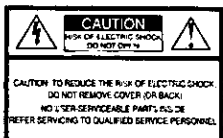

This symbol warns the user that uninsulated voltage within the unit may have sufficient magnitude to cause electric shock. Therefore, it is dangerous to make any kind of contact with any inside part of this unit.



This symbol alerts the user that important literature concerning the operation and maintenance of this unit has been included. Therefore, it should be read carefully in order to avoid any problems.

# Table of Contents

Use  
Now!

<b>Important Safeguards and Precautions</b> .....	<b>2</b>
<b>Accessories</b> .....	<b>4</b>
<b>Loading the Batteries</b> .....	<b>4</b>
<b>Basic Connections</b> (Antenna, VCR, TV) .....	<b>4, 5</b>
<b>One Time VCR Setup</b> (Language, Channel, Clock) .....	<b>6, 7</b>
<b>Playback a Tape</b> (Slow Motion, Still Picture, Frame by Frame) .....	<b>8</b>
<b>Record On a Tape</b> .....	<b>9</b>
• One Touch Recording .....	9

Basic Operation

Enjoy  
more!

<b>Advanced Connections</b> (Cable/DSS, Audio/Video) .....	<b>10, 11</b>
<b>Timer Recording</b> .....	<b>12, 13</b>
• Timer Recording .....	12
• Review, Replace or Clear Program Contents .....	13
<b>Multi-Brand Control Feature</b> .....	<b>14, 15</b>
<b>Tape Operation</b> .....	<b>16 ~ 18</b>
• VHS Index Search System .....	16, 17
• Auto Operation Functions .....	17
• Repeat Play .....	18
• Zero Search .....	18
• One Minute Skip .....	18
<b>Copying Your Tapes</b> (Dubbing) .....	<b>19</b>
<b>Special VCR Features</b> .....	<b>20 ~ 25</b>
• Channel Caption .....	20, 21
• Time Stamp .....	22, 23
• Tape Position Display .....	24
• Remote Warning ON/OFF .....	24
• VCR Lock .....	24
• Weak Signal Display ON/OFF ..	25
• Auto Shut-Off .....	25

Advanced Operation

Other  
Information!

<b>Reset Language, Channels, Clock</b> .....	<b>26, 27</b>
<b>VCR &amp; Cassette Information</b> .....	<b>28, 29</b>
• Reset All VCR Memory Functions ..	28
• DST (Daylight Saving Time) .....	28
• Prevent Accidental Tape Erasure .	28
• Record/Playback Time .....	28
• Head Cleaning .....	29
• Cleaning the VCR .....	29
• Specifications .....	29
• Features for Quality .....	29
<b>On-Screen Displays (OSD)</b> .....	<b>30</b>
• Function & Channel Display ....	30
• VCR Status & Clock Display ...	30
• Warning and Instruction Displays .....	30
<b>Before Requesting Service</b> .....	<b>31</b>
<b>Warranty</b> .....	<b>32, 33</b>
<b>Spanish (Español) Quick Use Guide</b> .....	<b>34, 35</b>
<b>Location of Controls</b> .....	<b>36, 37</b>
<b>Quick Use Guide</b> (Playback, Recording) .....	<b>Back Cover</b>

For Your Information

## Congratulations

on your purchase of one of the most sophisticated and reliable products on the market today. Used properly, it will bring you and your family years of enjoyment. Please fill in the information below. The serial number is on the tag located on the back of your VCR.

- Date of Purchase \_\_\_\_\_
- Dealer Purchased From \_\_\_\_\_
- Dealer Address \_\_\_\_\_
- Dealer Phone No. \_\_\_\_\_
- Model No. **PV-9405S** \_\_\_\_\_
- Serial No. \_\_\_\_\_

## Accessories

- Remote Control  
VSQS1597

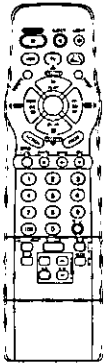

- Batteries 2 "AA"

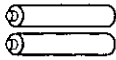

- RF Coaxial Cable  
VJAS0196



## Loading the Batteries

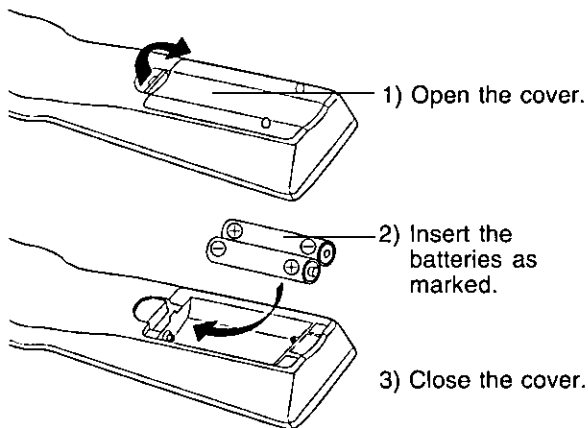

- Battery replacement caution**
- Do not mix old and new batteries.
  - Do not mix alkaline with manganese batteries.

## ANTENNA (See page 5)

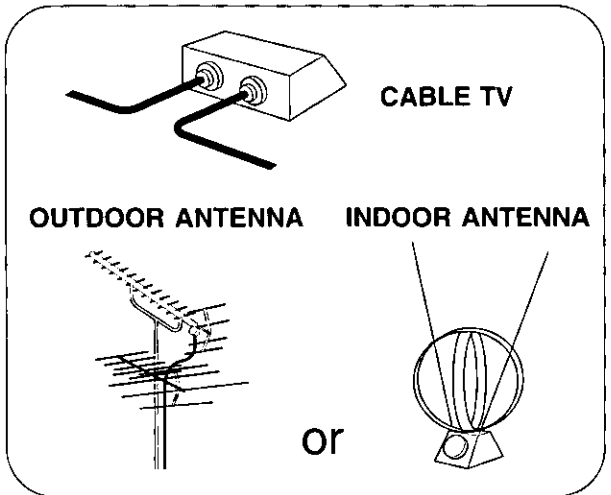

## VCR

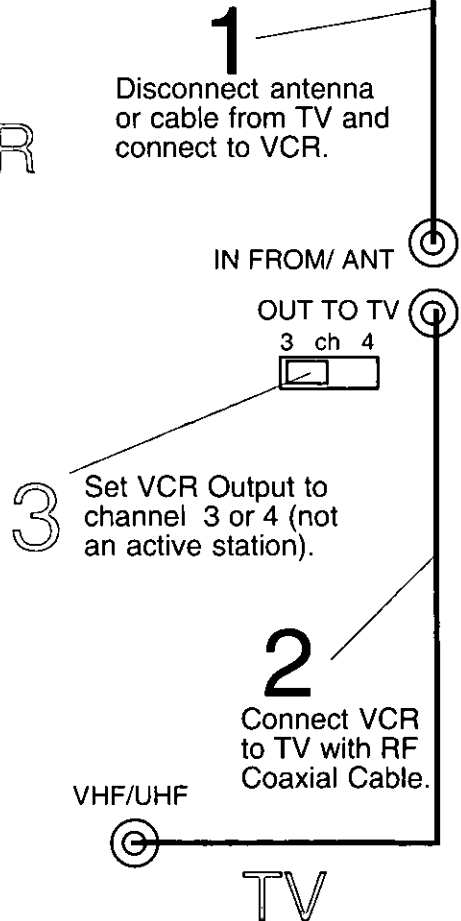

Tune TV to VCR output channel the same one you set in step 3.

### WARNING

When using "Nut type" RF coaxial cables, tighten with fingers only. Overtightening may damage terminals.

# 1 Between ANT. and VCR

## ■ Case 1: Twin Lead Cable Only

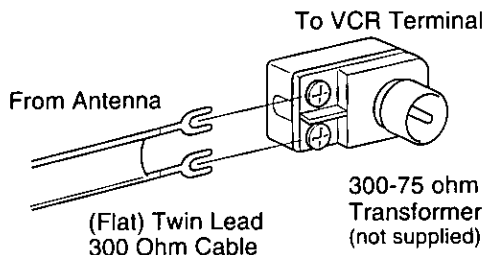

## ■ Case 2: Twin Lead & Coaxial Cables

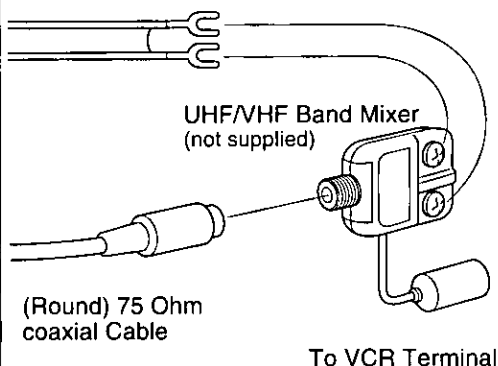

## ■ Case 3: Two Twin Lead Cables

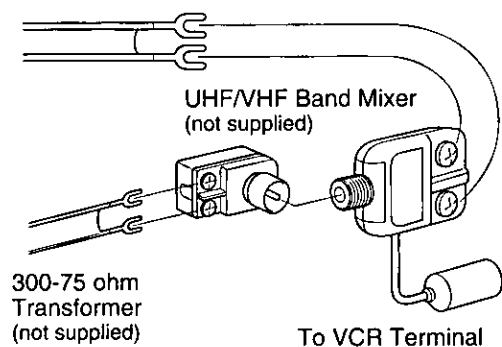

- If your TV has both post and plug-type VHF terminals, the post connection is recommended to minimize signal loss.

# 2 Between VCR and TV

## ■ Case 1: Screw & Plug Type Terminal

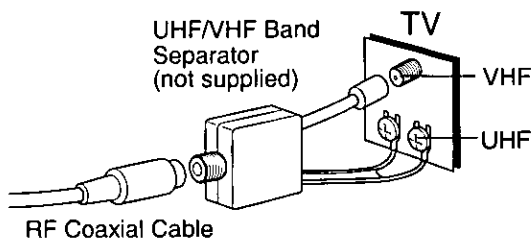

## ■ Case 2: Screw Type Terminal

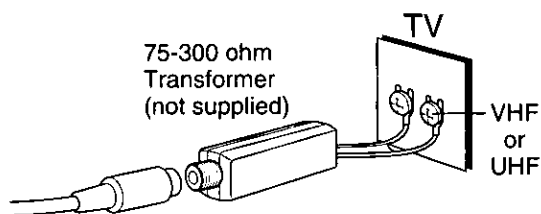

## ■ Case 3: Double Screw Type Terminal

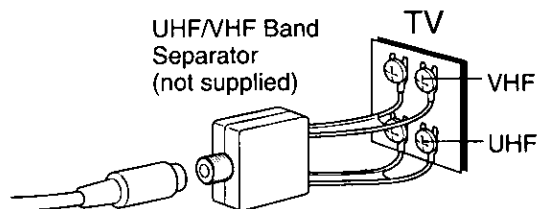

## ■ Case 4: Complex TV Terminal TERMINALS ON BACK OF TV SET

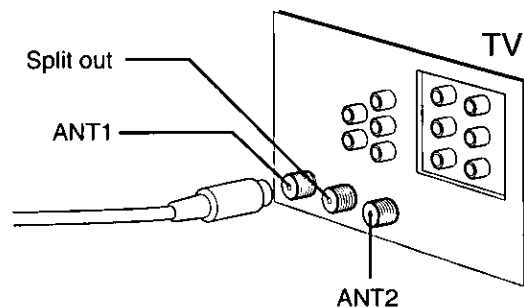

- Connect to one of the ANT terminals and select the same antenna number on the TV.

# One Time VCR Setup

When VCR is turned on the first time, setup mode is entered automatically.

## Process of Setup

Language ⇨ Channel ⇨ Clock

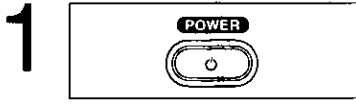

**1** Turn the TV and VCR on. Press POWER.

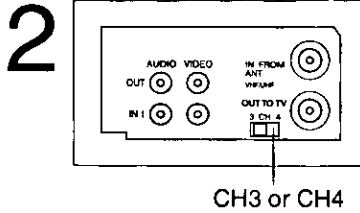

**2** Tune to VCR output channel. Tune TV to CH3 or CH4. (Same as back of VCR)

- Always tune TV to this channel to monitor the VCR.
- If you used audio/video jack connection, tune the TV to its video input.

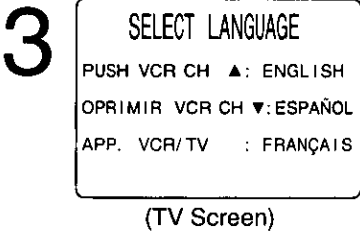

**3** Select the language.

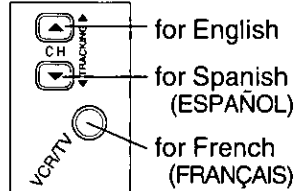

- Use remote or VCR buttons.
- If wrong language is set, do "Reset All VCR Memory Functions" steps page 28.

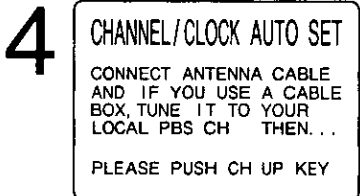

**4** Start Channel Auto Set and Clock Auto Set.

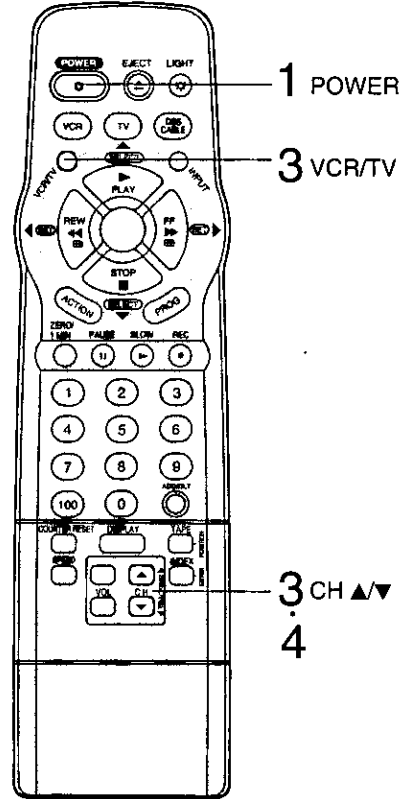
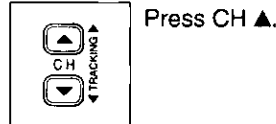

**Case 1** (Setup completed)

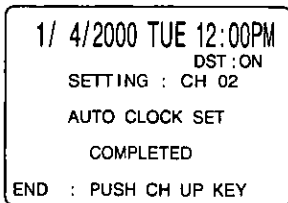

Press CH ▲ to exit.  
• If your area observes DST (daylight saving time), but the time is incorrect; do the "Time Zone Adjust" steps on page 27.

**Case 2** (Setup incomplete)

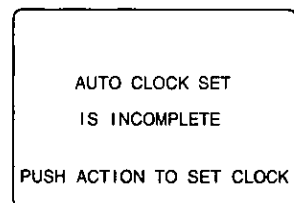

See next page.

**Case 2** Clock Setup incomplete.

AUTO CLOCK SET  
IS INCOMPLETE  
PUSH ACTION TO SET CLOCK

**Set the clock manually.**

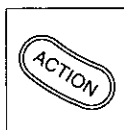

1) Press ACTION.

SET CLOCK  
DST: ON  
SELECT MONTH  
SELECT: ▲ ▼ KEY  
SET : ► KEY  
END : ACTION KEY

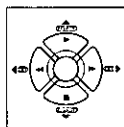

2) Press ▲▼ to select month.

3) Press ► to set.

- Likewise, set date, year, time, DST (Daylight Saving Time).

**To Make Corrections,**  
repeatedly press ◀▶ to move to error, then correct.

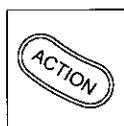

4) Press ACTION.  
(Clock starts.)  
• To exit this mode, press ACTION again.

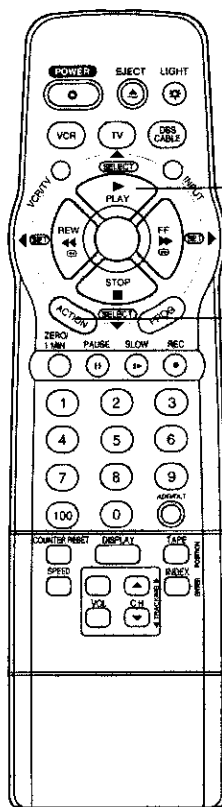

SELECT/  
SET  
▲:PLAY  
▼:STOP  
◀:REW  
▶:FF

ACTION

SET CLOCK  
1/ 4/2000 TUE 12:00PM  
DST: ON  
SET COMPLETED  
SET : ◀▶ KEY  
START : ACTION KEY

**Notes**

- VCR calendar is accurately maintained to Dec. 31, 2096 11:59PM.
- Channel auto set selects normal TV or Cable channels depending on your VCR hookup.

**IMPORTANT NOTE FOR AUTO CLOCK SET**

- Auto clock set is performed the first time the VCR is turned off each day. If used, a cable box must be left on and tuned to the PBS channel at the time VCR power is turned off if you want auto clock set to be done.
- If using, a DSS receiver must be turned off for auto clock set.
- If Cable Box or DSS receiver is connected to VCR via Audio/Video jacks, an RF coaxial cable must also be connected for auto clock set and channel auto set features.

**Using ▲▼◀▶ keys**

You can also operate the menu screen using VCR buttons.

If you use VCR buttons, press CH ▲ and CH ▼ together to display the menu screen.

When menu screens are displayed, PLAY, STOP, REWIND, and FF buttons function as ▲▼◀▶ only.

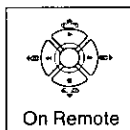

On Remote

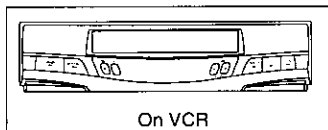

On VCR

▲ : PLAY  
▼ : STOP  
◀ : REW  
▶ : FF

# Playback a Tape

## Check list before you begin.

- All connections are made.
- TV and VCR are plugged in.
- TV is turned on and set to the VCR channel (CH 3 or 4).
- Remote is in VCR mode.

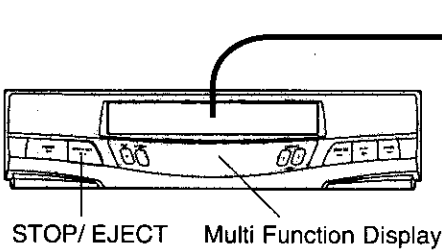

1

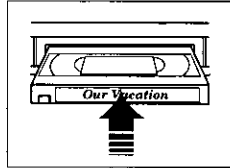

### Insert a cassette.

- VCR power comes on and VCR appears on Multi Function Display.

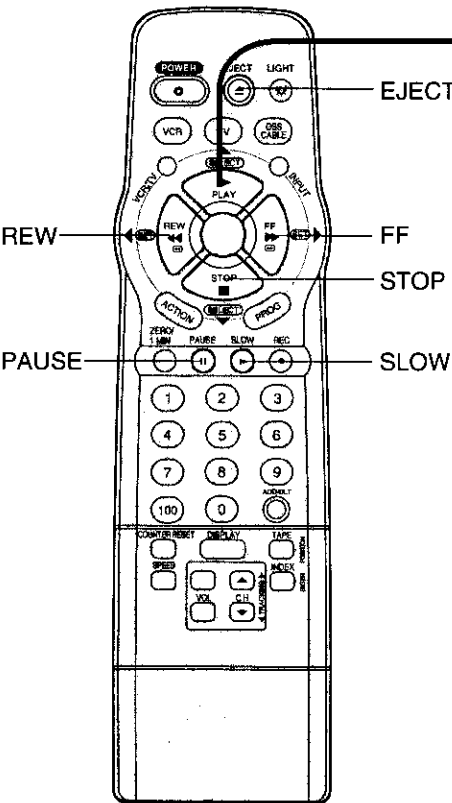

2

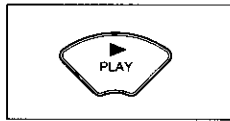

### Press PLAY.

- Playback begins if cassette has no record tab.

- To Find a Particular Scene  
Forward Search --> Press FF.  
Reverse Search --> Press REW.
- For Slow Motion --> Press SLOW.  
(To release, press SLOW.)
- For Still (Freeze) picture --> Press PAUSE.  
(To release, press PAUSE.)
- For Frame by Frame picture --> Press SLOW in Still mode.  
(To release, press PAUSE.)

### Notes

- To reduce picture noise, see "Manual Tracking Control" on page 29.
- After the VCR is in Still or Slow mode for 3 minutes, it will switch to Stop mode automatically to protect the tape and the video head.

- To stop --> Press STOP.
- To rewind tape --> Press REW in Stop mode.
- To fast forward tape --> Press FF in Stop mode.
- To eject tape --> Press EJECT on the remote or STOP/ EJECT on the VCR.

### Note

- To prevent tape jam  
Inspect your cassette tapes and remove any loose or peeling labels.

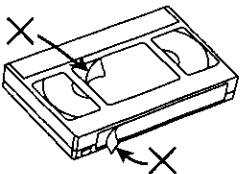

### Playback using VCR controls

1 Insert a cassette.

2 Press PLAY.



- Press to stop and/ or eject tape.



# Record On a Tape

**\*Important:**

If the remote control POWER, ACTION, PROG, CH ▲/▼, INDEX, NUMBERED keys, INPUT, TAPE POSITION, or ADD/ DLT button does not work when pressed, press the VCR button on the remote and try the button again.

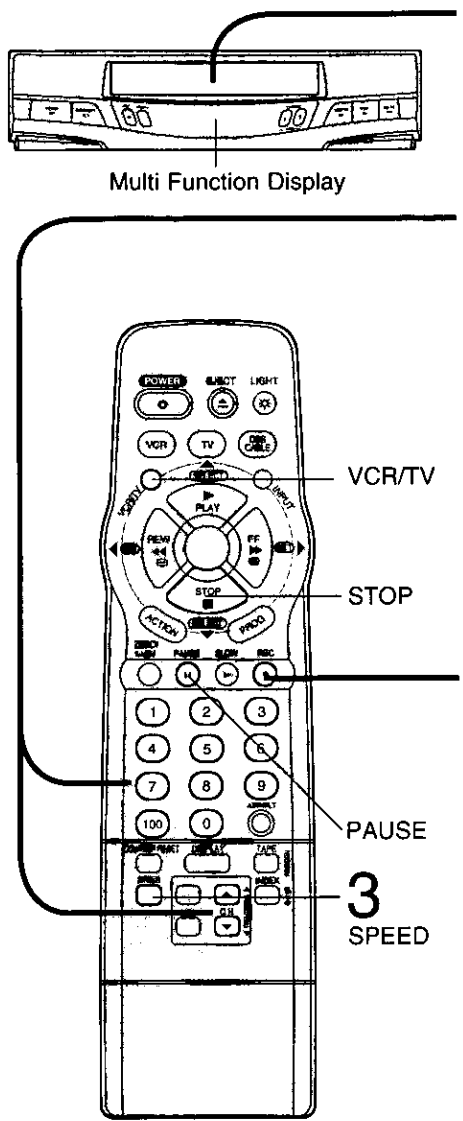

**Check list before you begin.**

- All connections are made.
- TV is turned on and set to the VCR channel (CH 3 or 4).
- Cassette with record tab in place.
- Remote in VCR mode.

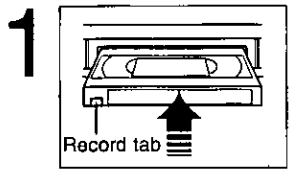

**Insert a cassette.**

- VCR power comes on automatically.

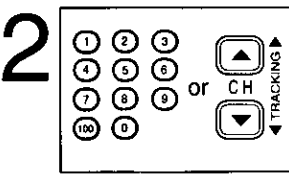

**Select Channel.**

Press CH ▲/▼\* or NUMBERED keys.

- To select "LINE", see page 19.
- To select channels over 100, first press 100 key, then enter remaining two digits.

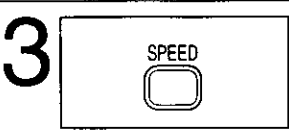

**Select Recording speed.**

(See page 28.)

Press SPEED.

- SP = Standard Play
- LP = Long Play
- SLP = Super Long Play
- Selected speed is displayed on TV screen and Multi Function Display.

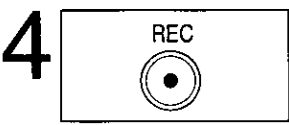

**Start Recording.**

Press REC.

- To edit out unwanted portions, press PAUSE to pause and resume recording.

■ **To stop --> Press STOP**

■ **One Touch Recording**

Press REC repeatedly to set the recording length (30 min. ~ 4 hours).

- The VCR turns itself off at a preset time.

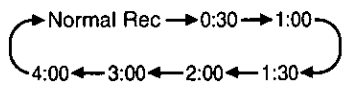

■ **Record One Program While Watching Another**

Press VCR/TV-->"VCR" disappears on Multi Function Display --> Select Channel at the TV.

■ **Selecting Channel at the VCR**

Press VCR/TV-->"VCR" appears on Multi Function Display --> Select Channel at the VCR.

**You can operate on the VCR**

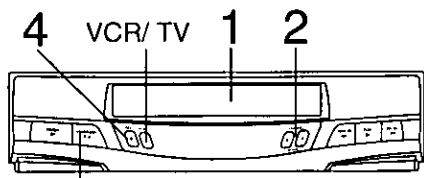

■ Press to stop.

**Note**

After the VCR has been in Pause mode for 5 minutes, it will stop automatically to protect the tape and the video head.

# Advanced Connections

## CATV Connection

Make sure to tune TV to VCR output channel the same one you set on back of VCR: CH3 or CH4.  
All connections on these pages are made with 75 Ohm coaxial cables.

### ■ With a Cable Box (Cable Box → VCR)

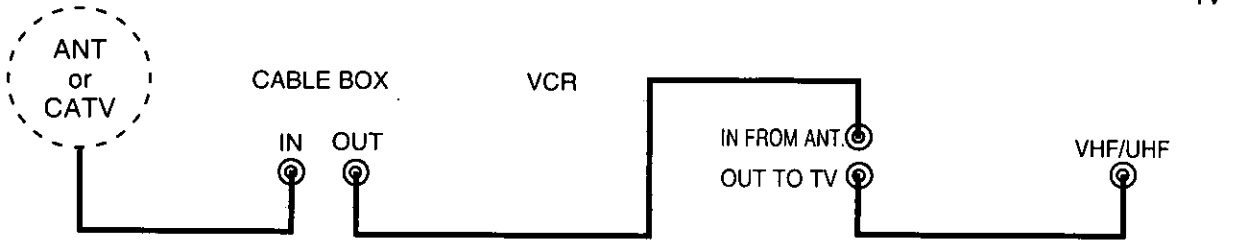

### ■ With a Cable Box (VCR → Cable Box)

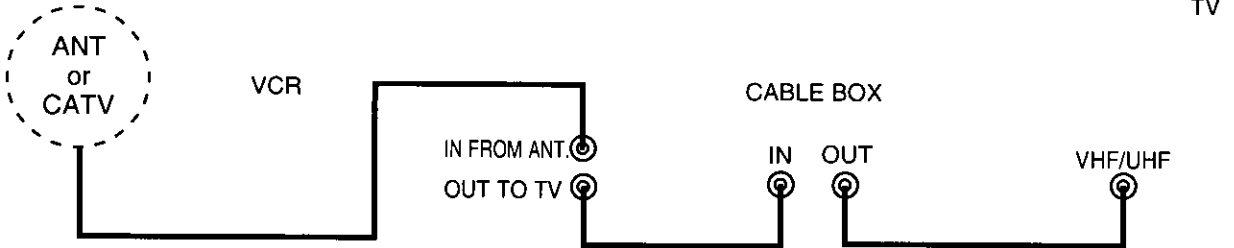

### ■ With Two Cable Boxes

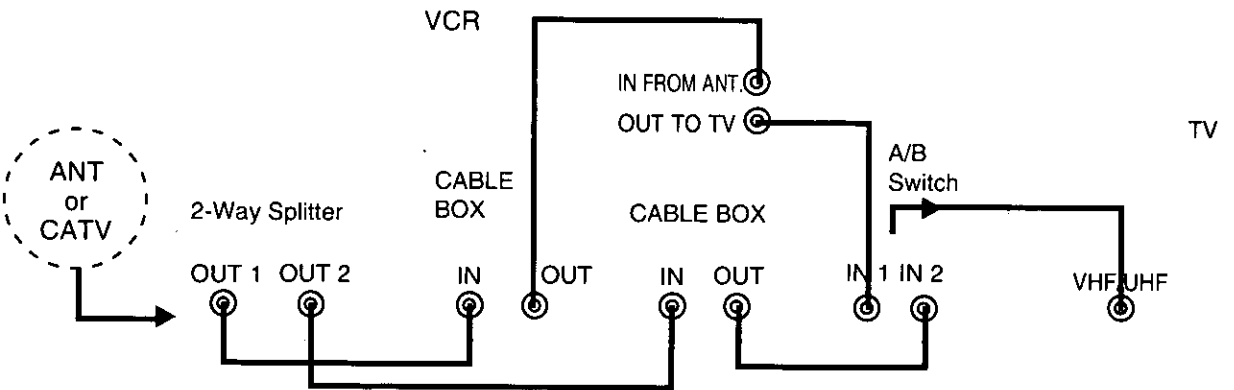

## DSS Connection

\* DSS® is a registered trademark of DIRECTV, INC., a unit of GM Hughes Electronics.

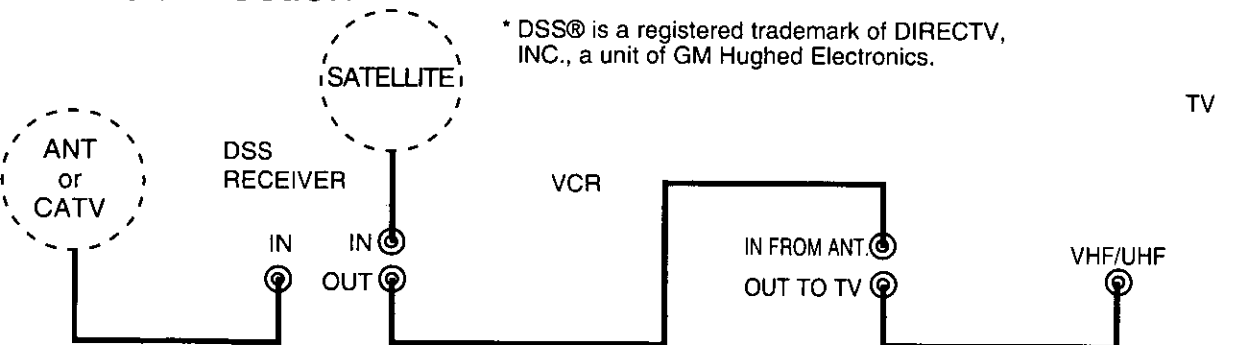

## You Can

- record or view any (including scrambled) channel.
- use VCR Remote Control to select channels using Multi-brand control feature.

## You Cannot

- view channel other than the one selected for any type of recording.
- do a Timer recording of a channel unless you select it at the cable box.

- view any (including scrambled) channel.
- use VCR Remote Control to select channels without using Multi-brand control feature.

- record scrambled channels.

- record and view both scrambled and unscrambled channels if additional equipment is added. This connection requires: two converter boxes, an A/B switch, and a 2-way splitter.

- view channel other than the one selected for any type of recording.
- do a Timer recording of a channel unless you select it at the cable box.

- record and view any (including scrambled) channel.
- use your VCR Remote Control to select channels using Multi-brand control feature.

- view channel other than the one selected for any type of recording.
- do a Timer recording of a channel unless you select it at the DSS box.

**NOTE:**  
DSS receiver must be turned off to view cable box or antenna programs.

## Audio/Video Connections

If your TV has AUDIO and VIDEO IN terminals, connect them to VCR for higher quality picture and sound.

### VCR

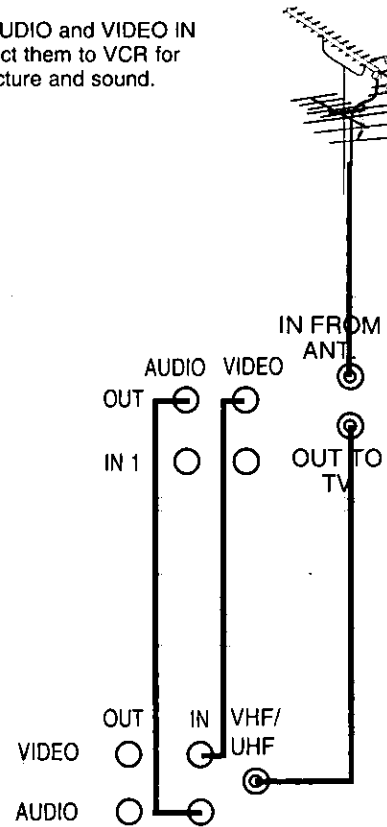

### TV

#### Note

To use your TV as a VCR monitor, set the VIDEO/TV selector on the TV (Monitor/Receiver) to "VIDEO."

#### Note to CABLE system installer:



This reminder is provided to call the CABLE system installer's attention to Article 820-40 of the NEC in USA (and to the Canadian Electrical Code in Canada) that provides guidelines for proper grounding and, in particular, specifies that the cable ground shall be connected to the grounding system of the building, as close to the point of cable entry as practical.

**FCC Warning:** Any unauthorized changes or modifications to this equipment would void the user's authority to operate.

This video recorder, equipped with the HQ (High Quality) System, is compatible with existing VHS equipment. Only use those tapes with the **VHS** mark. It is recommended that only cassette tapes that have been tested and inspected for use in 2, 4, 6, and 8 hour VCR machines be used.

# Timer Recording

You can set up to 8 programs to be recorded while you are away.

**1**  **Display menu.** Press ACTION.\* **or**  **Display program screen.**

- 1) Press PROG.
- 2) Go to step 4.

- \* You can also set up using VCR buttons. See the bottom right of this page.
- \* If a program is already in memory, press ▲▼ and ► to select an unused program number.

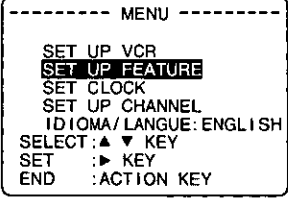
**2**  **Display SET UP FEATURE.**

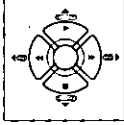

- 1) Press ▲▼ to select.
- 2) Press ► to display.

- \* You may not use the VCR buttons on "SET PROGRAM" screen.

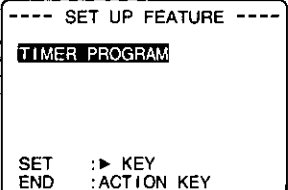
**3**  **Display Program screen.**

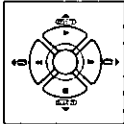

- 1) Press ► to display.

- \* If a program is already in memory, press ▲▼ and ► to select an unused program number.

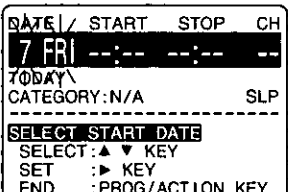
**4**  **Set the recording DATE.**

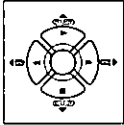

- 1) Press ▲▼ to select.
- 2) Press ► or ◀ to set.

- \* 1-31 = One time
- \* DAILY = MON-FRI
- \* WEEKLY = Same time once a week

**Example**

Today — 7 — SELECT ▲ / ▼ Selection Order — DAILY

WEEKLY (SAT) ..... WEEKLY (MON) ..... WEEKLY (SUN)

Repeat step 4 to set: start time, stop time, Channel (or LINE for outside source), Category\*\*, tape speed (SP, LP, SLP).

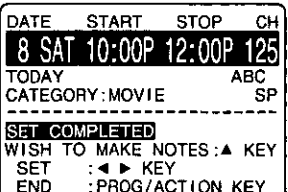
**5**  **Make the notes.**

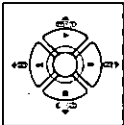

- 1) Press ▲ to begin.
- 2) Press ▲▼ to select.
- 3) Press ► to set.

- \* If not wanted, go to step 6.
- \* Characters will change in the following order.

→ A ↔ B ↔ C ..... Z ↔ BLANK ↔ — ↔ & ↔ —

→ 9 ..... 2 ↔ 1 ↔ 0 ↔ / ↔ + ↔ —

4) Press PROG (or ACTION) to end.

Continued on the next page.

- Check list before you begin.**
- All connections are made. (See pages 4-5.)
  - TV and VCR are plugged in and turned on.
  - VCR/TV selector is set to "VCR."
  - Clock is set to correct time.
  - Record tab in place. (See page 28.)
  - Remote in VCR mode.

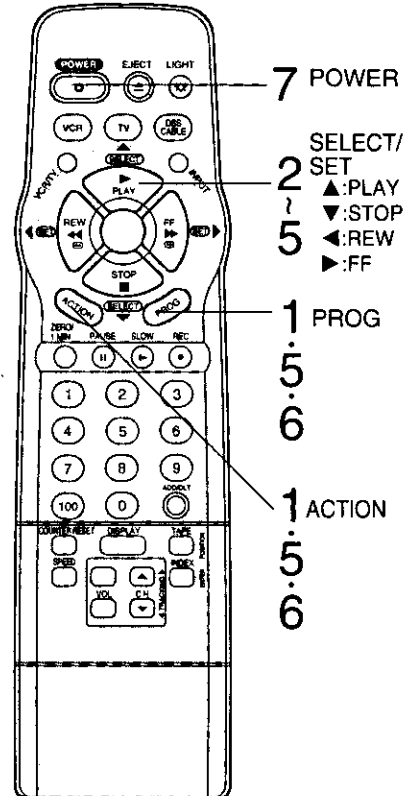

\*\* Category Items  
N/A(not applicable), SPORTS, MOVIE, COMEDY, MUSIC, DRAMA

## Using ▲▼◀▶ keys

You can also operate the menu screen using VCR buttons.

If you use VCR buttons, press CH▲ and CH▼ together to display the menu screen.

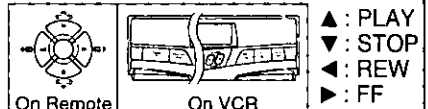

When menu screens are displayed, PLAY, STOP, REWIND, and FF buttons function as ▲▼◀▶ only.

## Important notes when using a DSS receiver

- \* When recording programs via a DSS receiver, the DSS receiver must be left on.
- \* When recording programs via an antenna or cable, the DSS receiver must be turned off.

**Important:** If the remote control POWER, ACTION, CH▲/▼, INDEX, PROGRAM keys, INPUT, TAPE POSITION, or ADD/HLT button does not work when pressed, press the VCR button on the remote and try the button again.

**6**

P	DT	START	STOP	CH	SPD
1	8	10:00P	12:00P	125	SP
2	---	---	---	---	---
3	---	---	---	---	---
4	---	---	---	---	---

CANCEL: ADD/HLT KEY  
 SELECT 1-8: ▲ ▼ KEY  
 ENTER : ► KEY  
 END : PROG/ACTION KEY

**End the program.**



1) Press PROG (or ACTION).

**To Enter More Programs**  
 Press ▲▼ to select, and ► to display a blank program number. Then repeat steps 4 and 5.

2) Press PROG (or ACTION) again to exit.

**To cancel Timer Recording (Recording is in progress)**

Press POWER and then STOP within 10 seconds to cancel the Timer recording. (The TIMER indicator goes out on Multi Function Display.)

**7**



Multi Function Display

**Set the timer.**

**Press Power OFF.**

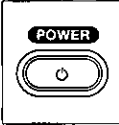

- When recording programs via a cable box, make sure the cable box is left ON and tuned to the desired channel.

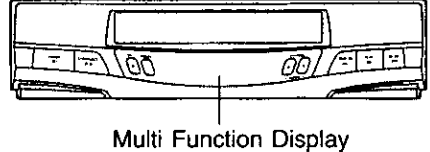

**Review, Replace or Clear Program Contents:**  
 (Recording is not in progress)

**a** Repeat steps 1~3 on page 12.  
 • If necessary, press POWER ON.

**b**

P	DT	START	STOP	CH	SPD
1	DAY	9:00A	12:00A	08	SP
2	8	10:00P	12:00P	125	SP
3	10	8:00P	9:00P	10	SP
4	SU	9:00P	10:00P	L	LP

CANCEL: ADD/HLT KEY  
 SELECT 1-8: ▲ ▼ KEY

**Select program.**

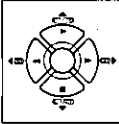

1) Press ▲▼ to select number.

**c** **To Replace program...**

DATE /	START	STOP	CH
8 SAT	10:00P	12:00P	125

TODAY \ ABC  
 CATEGORY: MOVIE  
 NOTES: STAND BY ME  
 SELECT START DATE  
 SELECT: ▲ ▼ KEY  
 SET : ◀ ▶ KEY

1) Press ► to display.  
 2) Press ▲▼◀▶ to set new program contents.

**To Clear program...**

P	DT	START	STOP	CH	SPD
1	---	---	---	---	---
2	8	10:00P	12:00P	125	SP
3	10	8:00P	9:00P	10	SP
4	SU	9:00P	10:00P	L	LP

SELECT 1-8: ▲ ▼ KEY  
 ENTER : ► KEY

**1) Press ADD/HLT.**

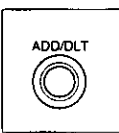

**d**



**End the program.**

1) Press PROG (or ACTION).  
 • If there are programs, press POWER OFF.

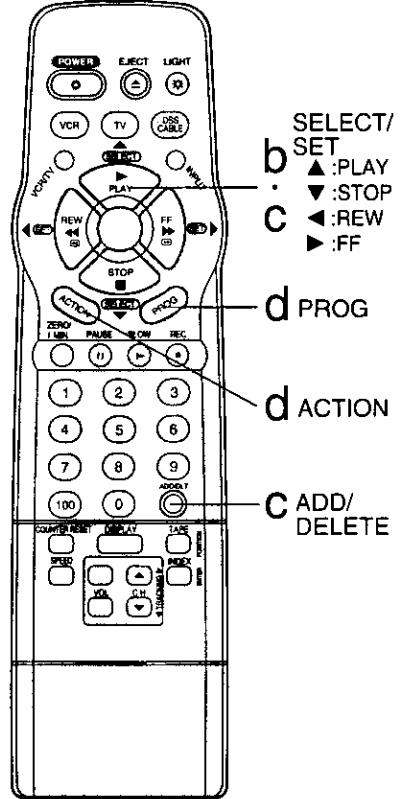

Timer Recording

# Multi-Brand Control Feature

The Remote Control may be set up to control some TV or Cable/DSS Box functions.

## Multi-Brand Control Setup

**1** Find your TV, Cable or DSS Receiver Brand Code Number on following page.

**2** Setup for TV

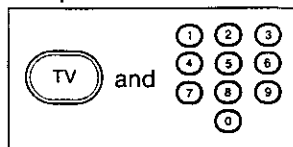

### Setup remote.

Hold down TV and enter code with NUMBERED keys.

Setup for Cable or DSS

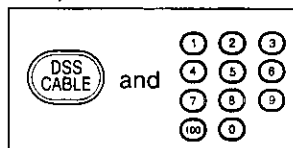

Hold down DSS/CABLE and enter code with NUMBERED keys.

- For code 100 or greater, press the 100 key first, then remaining digit. e.g. for 102, press 100, then press 0, and then press 2.

**3** POWER

### Confirm code entry.

Press POWER to turn selected unit ON or OFF.

- See table below for list of controllable functions in each mode.

### Notes

- Please repeat Multi-Brand Control setup after replacing remote control batteries.
- The remote control will not operate all TVs, Cable Boxes, and DSS receivers made by manufacturers listed. If you get no results, your particular brand cannot be controlled.

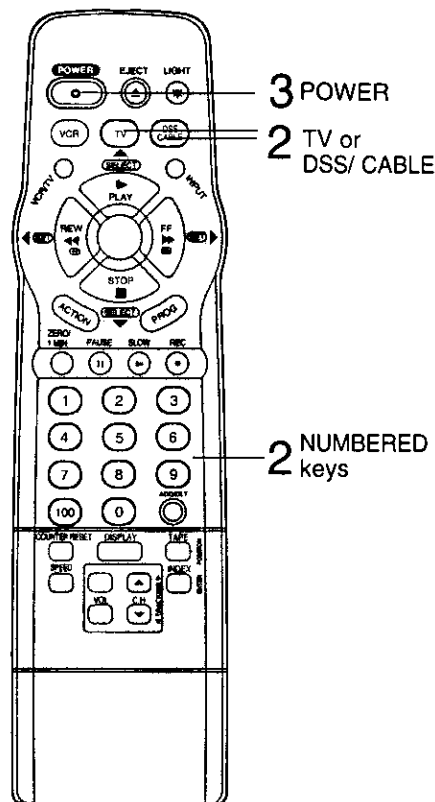

## Using the Multi-Brand Control

After remote control is setup, you can select VCR, TV, or DSS/CABLE for the desired function.

Press **VCR** or **TV** or **DSS/CABLE** on the remote control.

This table shows which buttons are available for each mode.

Mode \ Available Buttons	VCR	TV	CABLE/ DSS
<b>VCR</b>	All Functions	VOL UP/DOWN	—
<b>TV</b>	VCR/TV, PLAY, STOP EJECT, DISPLAY, FF, REW, PAUSE, SLOW, REC, SPEED, ZERO/ 1MIN, COUNTER RESET	POWER, INPUT, NUMBERED keys, ENTER, CH UP/ DOWN, VOL UP/DOWN	—
<b>CABLE/ DSS</b>	VCR/TV, PLAY, STOP EJECT, DISPLAY, FF, REW, PAUSE, SLOW, REC, SPEED, ZERO/ 1MIN, COUNTER RESET	VOL UP/ DOWN	POWER, ENTER, NUMBERED keys (except 100key), CH UP/ DOWN

**Note** In TV or DSS/ CABLE mode, it may be necessary to press ENTER after pressing NUMBERED keys for channel selection.

## TV Brand Code Numbers

Panasonic .....	01, 02	Sylvania .....	05	JVC .....	11
Quasar .....	01, 02	Sharp .....	06, 07	Hitachi .....	12
RCA .....	03	Sony .....	08	Mitsubishi .....	07, 13
GE .....	03	Toshiba .....	09	Samsung .....	14
Zenith .....	04	Sanyo .....	10	Gold Star .....	15, 16, 17
Magnavox .....	05	Fisher .....	10		

## Cable Box Brand Code Numbers

Archer .....	01, 05, 06, 44, 63, 91, 126	Quest .....	05, 06
Cabletenna .....	01, 44, 63, 91, 126	Radio Shack .....	44, 51, 59, 75
Cableview .....	04, 30, 42, 44, 52, 63, 124, 126	RCA .....	16, 17, 97, 109
Century .....	44, 51, 59, 75	Realistic .....	44, 51, 59, 75, 126
Citizen .....	04, 30, 42, 44, 52, 63, 124, 126	Recoton .....	44, 51, 59, 75, 126
Curtis .....	08, 09, 53, 61, 87	Regal .....	14, 15, 28, 41, 102, 103, 104, 108, 130
Diamond .....	01, 44, 63, 91, 126	Regency .....	28, 130
Drake .....	67	Rembran .....	01, 32, 39, 42, 44, 63, 126
Eagle .....	13, 20, 22, 26, 40, 58, 62, 107	Salora .....	68
Eastern .....	28, 130	Samsung .....	05, 06, 32, 40, 42
GC Brand .....	04, 30, 42, 44, 52, 63, 124, 126	Scientific Atlanta .....	08, 09, 53, 61, 87
Gemini .....	04, 124	Sheritech .....	27
General Electric .....	01, 57	Signal .....	26, 112
General Instruments .....	01, 02, 03, 04, 34, 55, 65, 67, 68, 83, 91, 115, 117, 118, 124	SL Marx .....	06, 32, 40, 42, 43, 44, 52, 63, 126
Hamlin .....	14, 15, 28, 41, 102, 103, 104, 108, 130	Spucer .....	16, 17, 97, 109
Hitachi .....	31	Standard Components .....	32, 39, 42, 44, 126
Jasco .....	04, 124	Stargate .....	04, 06, 30, 32, 40, 42, 44, 52, 63, 124, 126
Jerrold .....	01, 02, 03, 04, 34, 55, 65, 67, 68, 83, 91, 115, 117, 118, 124	Sylvania .....	19
Macom .....	31	Teknika .....	74
Magnavox .....	26, 112	Telecaption .....	77, 127
Matsushita .....	16, 17, 97, 109	Television .....	06, 32, 40, 42
Movietime .....	32, 38, 39, 40, 42, 44, 126	Texscan .....	18, 19
NEC .....	32, 38, 40	Tocom .....	01, 33, 34, 42, 66, 91
NOVAVISION .....	08, 09, 53, 61	Toshiba .....	36
NSC .....	32, 38, 40	Uniden Satellite .....	65
Oak .....	11, 46, 129	Unika .....	01, 44, 63, 91, 126
Oak Sigma .....	11, 46, 129	Universal .....	42, 43, 44, 52, 63, 126
Panasonic .....	16, 17, 97, 109	Videoway .....	07, 23, 50, 129
Philips .....	07, 13, 20, 23, 24, 50, 128, 129	Vid Tech .....	64
Pioneer .....	05, 06	Vidter .....	64
Pulsar .....	04, 30, 42, 44, 52, 63, 124, 126	Viewstar .....	13, 20, 22, 26, 40, 58, 62, 107
		Zenith .....	07, 23, 50, 129

## DSS Brand Code Number

Toshiba .....	92	Panasonic .....	96
Hitachi/ Hughes .....	93	RCA .....	97
Magnavox/ Uniden 1 .....	94	Sony .....	98, 105
Magnavox/ Uniden 2 .....	95		

### Important Notes

- Due to changes in infra-red commands used by manufacturers, some brands have several codes. If your unit does not respond to the first code, please try the next one.
- Some TV, Cable Box and DSS Box brands require you to turn on the power manually.
- Not all functions listed may be controlled by this remote control.

# Tape Operation

## VHS Index Search System

Each time recording is made, an invisible index mark is placed on the tape. When timer recordings are made, program index and information are also included. These index marks can be used to access or scan recordings.

### Direct Access (For normal and /or timer recordings)

Go directly to desired recording.



**Display SELECT SEARCH MODE.**

Press INDEX.\*

- If there are no timer recordings on the Program Index List, go to step 3.

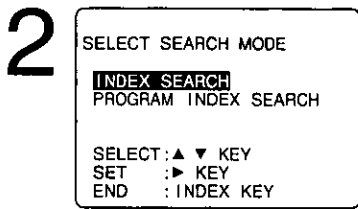

**Display INDEX.**

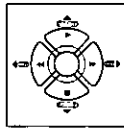

- 1) Press ▲▼ to select.
- 2) Press ▶ to display.

- This screen appears only if there are timer recordings.

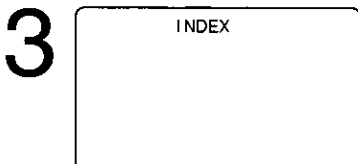

**Select the recording number.**

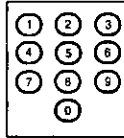

Press NUMBERED keys.

- To calculate number, see below.

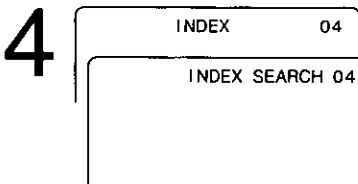

**Start search.**

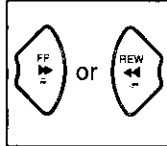

Press FF or REW.

- When search is finished, playback begins.

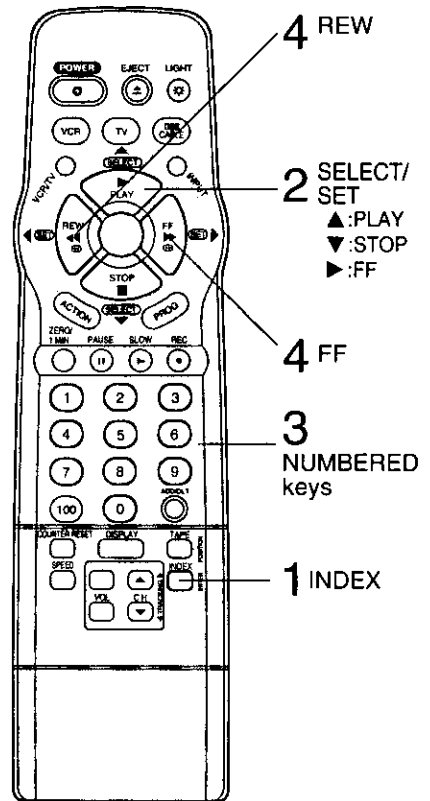

### ■ To Calculate Index Number

**Example 1:**

If you are watching recording 4 and you want to watch recording 2, enter 3 in step "3" and press REW.

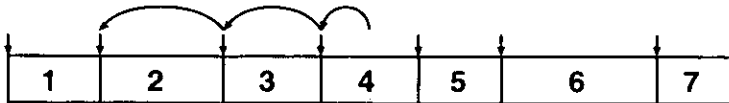

**Example 2:**

If you are watching recording 2 and you want to watch recording 6, enter 4 in step "3" and press FF.

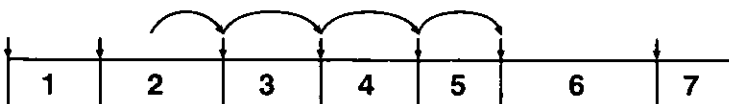

NOTE: ↓ indicates start points of each recording.

### Notes

- Make each entry within 10 seconds, or the Index Search mode will be canceled.
- If Direct Access or Index Scan is started very close to an index mark, that index mark may not be counted in the search.



**Important:** If the remote control POWER, ACTION, PROG, CH▲/▼, INDEX, TAPE POSITION, or ADD/HLT button does not work when pressed, press the VCR button on the remote and try the button again.

## Program Index Search (For timer recordings only)

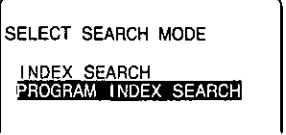
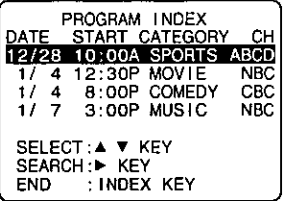

Choose a timer recorded program from a Program Index List. When the tape is ejected or normal recording is started, all program index data is deleted.

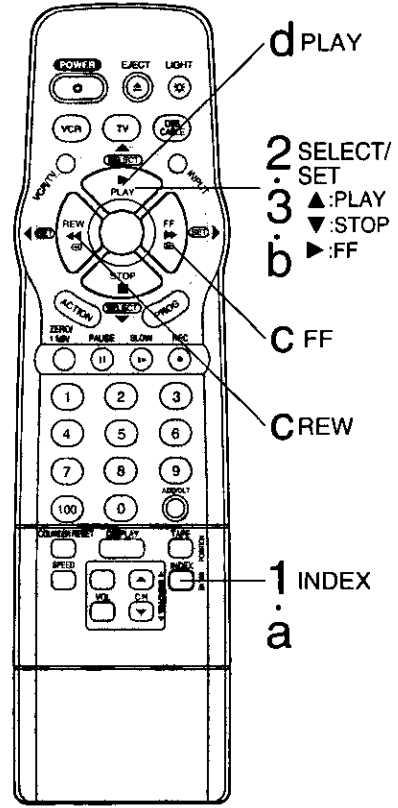
- 1**  **Display SELECT SEARCH MODE.**  
Press INDEX.
- 2**  **Display PROGRAM INDEX.**  
1) Press ▲▼ to select.  
2) Press ► to display.
- 3**  **Select the desired recorded program.**  
1) Press ▲▼ to select.  
2) Press ► to start the forward or rewind search.  
• When search is finished, playback begins.

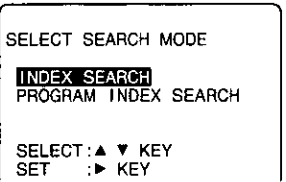

## Index Scan (For normal and /or timer recordings)

In Play mode, the first 10 seconds of each recording can be scanned (forward or reverse).

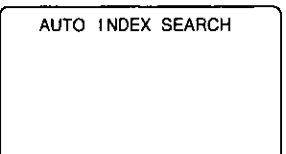
- a**  **Display SELECT SEARCH MODE.**  
Press INDEX.  
• If there are no timer recordings on the Program Index List, go to step c.
- b**  **Display INDEX.**  
1) Press ▲▼ to select.  
2) Press ► to display.
- c**  **Start scan.**  
Press FF or REW.
- d**  **Cancel scan, start playback.**  
Press PLAY.  
• To stop, press STOP.

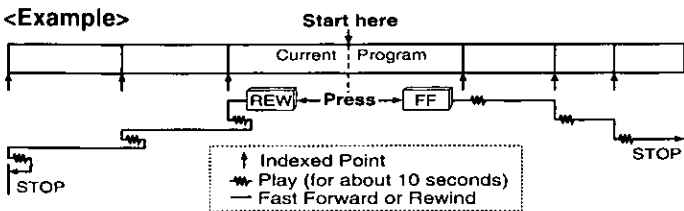

Tape Operation

## Auto Operation Functions

- Auto Playback**  
Tape insert --> Power turn on --> --> Start playback if record tab (see page 28) is removed.
- Auto Rewind**  
Playback  
Manual Record } --> Tape end --> Fast Forward  
--> Rewind (Auto)
- Playback Auto Eject (Repeat Play is "OFF")**  
Playback --> Rewind --> --> Tape eject (Without record tab)
- Memory Rewind Off**  
Rewind --> Press POWER --> --> Turn off after complete

# Tape Operation (continued)

## Repeat Play

Set to see a recording over and over.

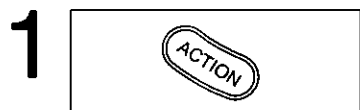

**Display menu.**  
Press ACTION.\*

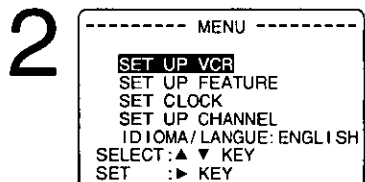

**Display SET UP VCR.**  
1) Press ▲▼ to select.  
2) Press ► to display.



**Set ON or OFF.**  
1) Press ▲▼ to select "REPEAT PLAY."  
2) Press ► to set.

• Playback repeats when tape end is reached or unrecorded portion over 30 seconds is detected.

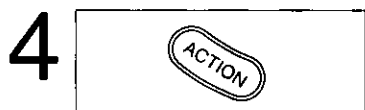

**Return to normal screen.**  
Press ACTION twice.

## Zero Search

To quickly return to specific tape counter location.

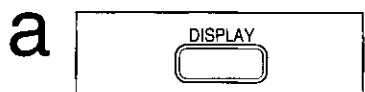

**Display Counter.**  
Press DISPLAY during playback.

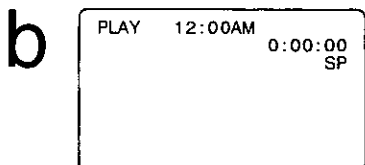

**Reset to "0:00:00."**  
Press COUNTER RESET at the desired position.

**c** Continue playback, rewind, or fast forward.

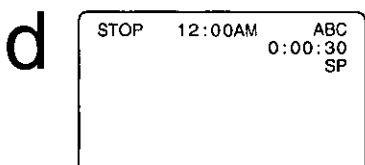

**Return to "0:00:00."**  
Press ZERO/ 1MIN in Stop mode.  
• The VCR will go into FF or REW mode and stop at the last point the Counter was set to 0:00:00.

### \*Important:

If the remote control POWER, ACTION, PROG, CH ▲/▼, INDEX, NUMBERED keys, INPUT, TAPE POSITION, or ADD/ DLT button does not work when pressed, press the VCR button on the remote and try the button again.

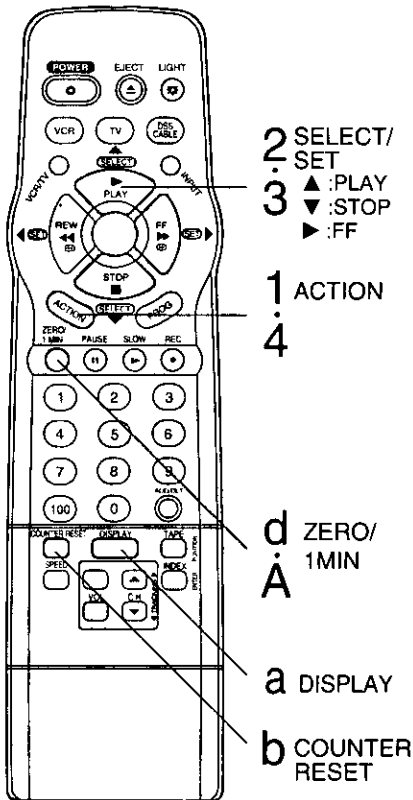

## One Minute Skip

VCR skips over 60 seconds of recorded tape.

**A** Press ZERO/ 1MIN in Play mode.

# Copying Your Tapes (Dubbing)

Connections you'll need to make.

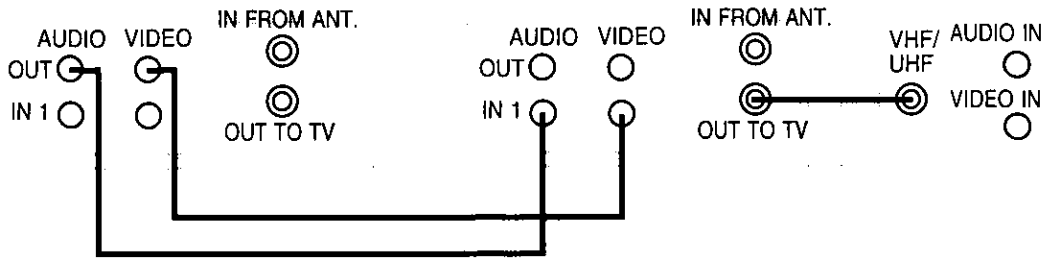

Playing (Source) VCR

Recording (Editing) VCR

TV for Monitoring

## Playing (Source) VCR

## Recording (Editing) VCR

**1**  **Insert pre-recorded tape.**

 **Insert blank tape with record tab.**

**2**  **Select LINE mode.**  
Press INPUT.  
(See "Selecting the Input Mode" below.)

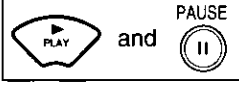
**3**  **Put in Standby mode.**  
Press PLAY, then PAUSE at starting point.

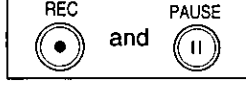
 **Put in Standby mode.**  
Press REC, then PAUSE immediately.

**4**  **Start dubbing.**  
Press PAUSE.

 **Start dubbing.**  
Press PAUSE.

**5**  **Stop dubbing.**  
Press STOP.

 **Stop dubbing.**  
Press STOP.

### ■ To Monitor Dubbing on Your TV

- 1 Turn your TV on and tune to the Recording VCR channel (CH3 or CH4).
- 2 Set the VCR/ TV Selector on the Recording VCR to "VCR."

### ■ Selecting the Input Mode

- Method 1: Press INPUT.  
Channel Number <-> LINE
- Method 2: Press CH ▲/▼.  
Display will change as below.

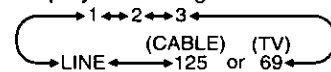

- "L" lights on Multi-Function Display (about 4 sec.) when LINE is selected.

**Note** Dubbing tapes protected with Copy Guard will have poor quality results.

**Caution:** Unauthorized exchanging and/or copying of copyrighted recordings may be copyright infringement.

# Special VCR Features

## Channel Caption

When set, station name, e.g. ABC, CBS, and channel number appear on-screen.  
Set up to 24 preset captions, and/or 10 manually created captions.

You need a list of stations and the channel numbers you receive them on.

### Preset Caption

**1**  **Display menu.**  
Press ACTION.\*

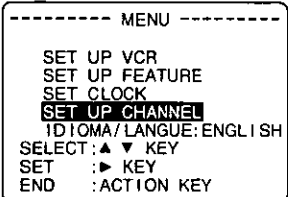
**2**  **Display SET UP CHANNEL.**  
1) Press ▲▼ to select.  
2) Press ► to display.

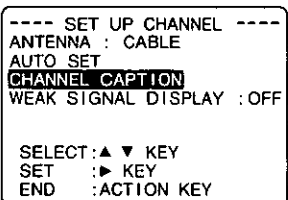
**3**  **Display CHANNEL CAPTION.**  
1) Press ▲▼ to select.  
2) Press ► to display.

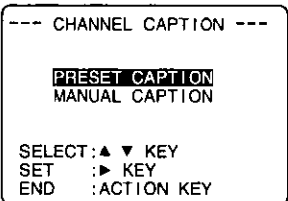
**4**  **Display PRESET CAPTION.**  
1) Press ▲▼ to select.  
2) Press ► to display.  
• To create your own captions, go to "Manual Caption" on page 21.

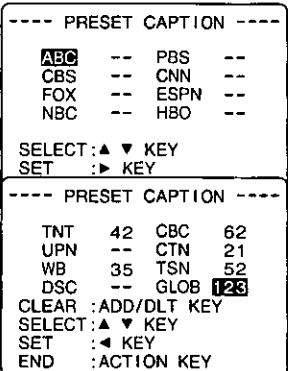
**5**  **Assign preset captions.**  
1) Press ▲▼ to highlight caption.  
2) Press ► to move cursor to the right.  
3) Press ▲▼ to select CH number.  
4) Press ◀ to set.  
• Repeat step 5 until the list is complete.  
**To make corrections,**  
Press ▲▼ and ► to select the channel number, then press ▲▼ to change, or ADD/DLT to delete the number.

**6**  **End setup.**  
Press ACTION four times.

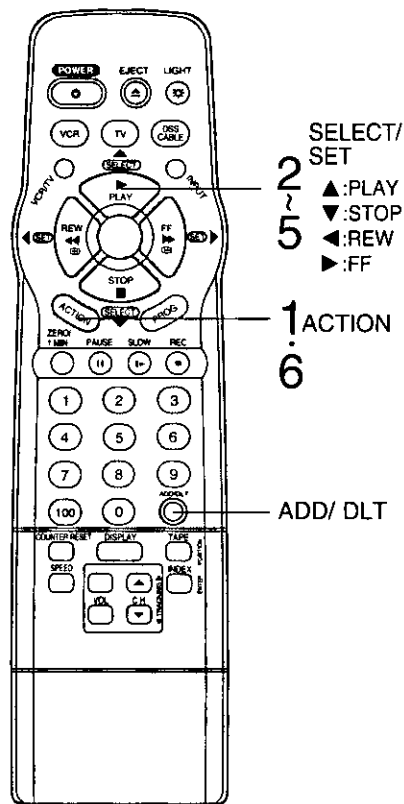

## Manual Caption

**1** Do "Preset Caption" steps 1~3 on page 20.

**2**

--- CHANNEL CAPTION ---

PRESET CAPTION  
MANUAL CAPTION

SELECT :▲ ▼ KEY  
SET :▶ KEY  
END :ACTION KEY

**Display MANUAL CAPTION.**

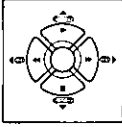

- 1) Press ▲▼ to select.
- 2) Press ▶ to display.

**3**

---- MANUAL CAPTION ----

CH NUMBER	CAPTION
02	----

SELECT :▲ ▼ KEY  
SET :▶ KEY  
END :ACTION KEY

**Select channel number.**

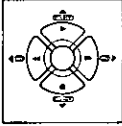

- 1) Press ▲▼ to select CH NUMBER.
- 2) Press ▶ to move cursor to the right.

- Channels already set and channels deleted from Channel Memory are not displayed.
- You can set a total of ten channel captions.

**4**

---- MANUAL CAPTION ----

CH NUMBER	CAPTION
02	A----

CLEAR :ADD/HLT KEY  
SELECT :▲ ▼ KEY  
SET :◀▶ KEY

**Enter CAPTION.**

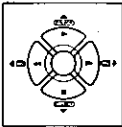

- 1) Press ▲▼ to select.
- 2) Press ▶ to enter.

- Characters change in following order.

→A↔B↔C↔...↔Z↔BLANK↔-↔&↔  
→9↔...↔2↔1↔0↔+↔!↔

- 3) Press ◀ to set.

- Repeat steps 3 and 4 as desired.

**To make corrections,**

Press ◀▶ to move to the incorrect entry, then press ▲▼ to make correction. Or, press ADD/HLT to clear the caption.

**5**

**End input.**

Press ACTION four times.

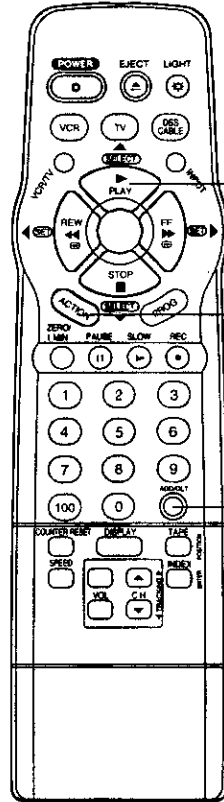

- 2 SELECT/SET
- 3 ▲:PLAY
- 4 ▼:STOP
- 5 ACTION

ADD/ DLT

# Special VCR Features (continued)

## Time Stamp Feature

The VCR writes program data (see example below) about the first 10 seconds of every recording. The information is then displayed the first 10 seconds of playback. To change the data, see "Changing Time Stamp Data" on page 23.

- Check list before you begin.
- Clock is set to correct time.
  - Record tab in place. (See page 28.)

**1**  **Display menu.**  
Press ACTION.\*

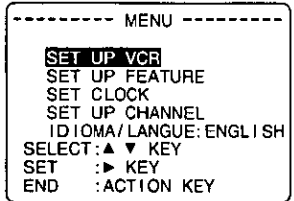
**2**  **Display SET UP VCR.**

1) Press ▲▼ to select.  
2) Press ► to display.

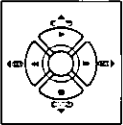

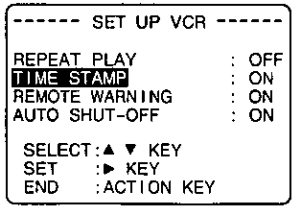
**3**  **Set ON or OFF.**

1) Press ▲▼ to select.  
2) Press ► to set.

• When "OFF" is selected, the program data is written on the tape, but will not be displayed.

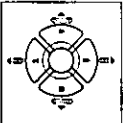

**4**  **Return to normal screen.**  
Press ACTION twice.

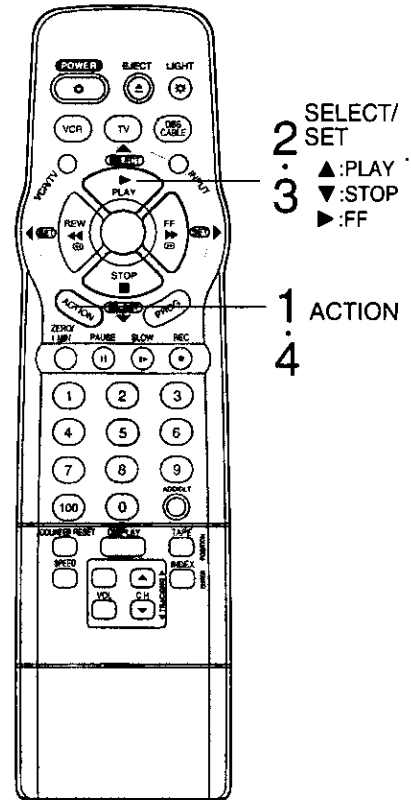

### <Time Stamp Example>

#### One Touch Recording

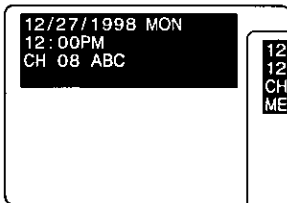

#### Timer Recording

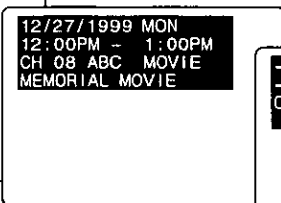

#### When Clock is not set...

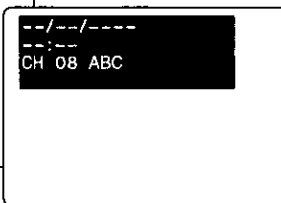

**Important:** If the remote control POWER, ACTION, PROG, CH▲/▼, INDEX, NUMBERED keys, INPUT, TAPE POSITION, or ADD/HLT button does not work when pressed, press the VCR button on the remote and try the button again.

## Changing Time Stamp Data

You may change the Date, Time, Channel, Category, and Notes.

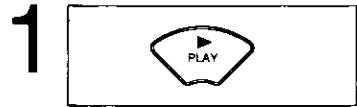

**Display Time Stamp Data.**  
 1) Insert cassette with record tab.  
 2) Press PLAY.

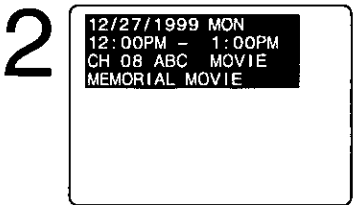
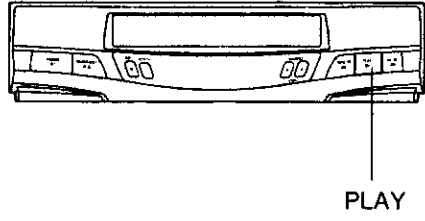

**Display TIME STAMP EDIT.**  
 Press PROG while the data is displayed in Playback mode.

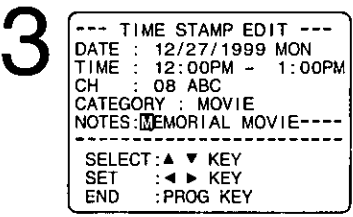

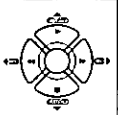

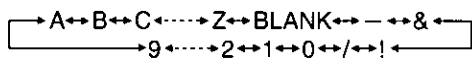
**Change Time Stamp Data.**  
 1) Press ▲▼ to select.  
 2) Press ► to enter and continue.  
 • Characters in NOTES will change in the following order.

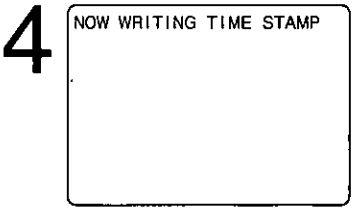

3) Repeat 1) and 2) as needed.

**To make corrections,**  
 Press ◀▶ to move to the incorrect entry, then press ▲▼ to make the correction.



**Write the new data.**  
 Press PROG.  
 • When data is written, VCR returns to Stop mode.

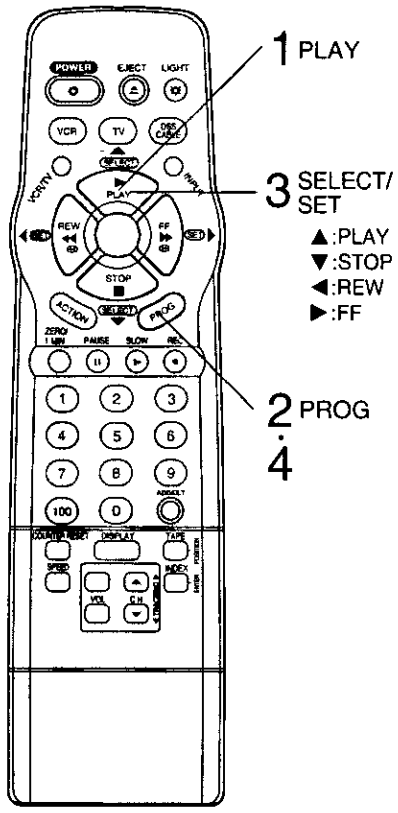

**Special VCR Features**

# Special VCR Features (continued)

## Tape Position Display Feature

To find out the present tape position.

**Tape position cannot be found for C-Cassette type and tape of less than 60 minutes.**

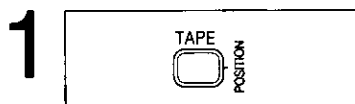

**Detect Tape Position.**  
Press TAPE POSITION.\*

DETECTING TAPE POSITION

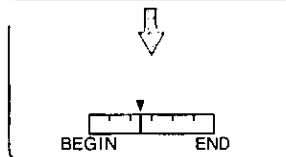

- Detecting tape position is only displayed when cassette is first inserted.
- It takes several seconds for correct indication to appear.
- Indication is standard.

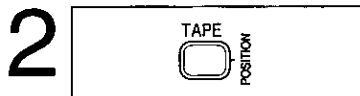

**Return to normal screen.**  
Press TAPE POSITION.

## Remote Warning ON/OFF Feature

If Multi-brand feature is used (page 14), and this feature is set to on, a warning appears whenever an invalid key is pressed in TV, DSS, or Cable mode.

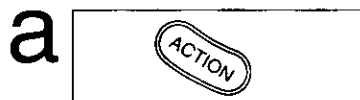

**Display menu.**  
Press ACTION.

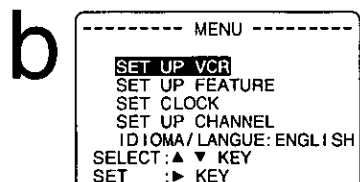

**Display SET UP VCR.**

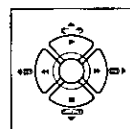

- 1) Press ▲▼ to select.
- 2) Press ► to display.



**Set ON or OFF.**

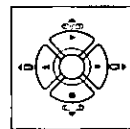

- 1) Press ▲▼ to select.
- 2) Press ► to set.

• "OFF" -> Remote warning will not appear even if invalid key is pressed.

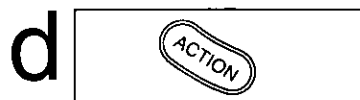

**Return to normal screen.**  
Press ACTION twice.



**Check list before you begin.**

- All connections are made. (See pages 4~5.)
- VCR is plugged in.
- TV is turned on and set to the VCR channel (CH 3 or 4).

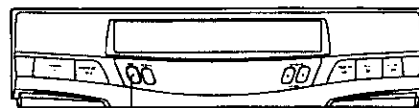

REC

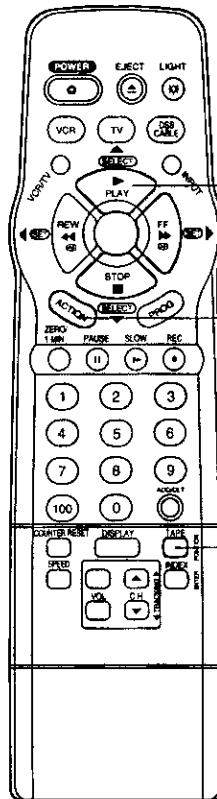

**b** SELECT/SET

**c** ▲:PLAY  
▼:STOP  
►:FF

**a** ACTION

**d**

**1** TAPE POSITION  
**2**

## VCR Lock Feature

All operations are prohibited except timer recording and tape eject. Useful for families with small children.

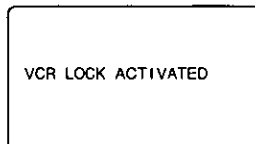

**To turn ON:**  
In Stop mode, hold down REC on the VCR without a cassette inserted for 7 seconds.

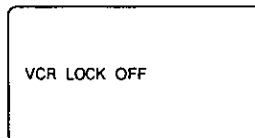

**To turn OFF:**  
Repeat above.

- VCR Lock is canceled automatically after 24 hours if clock is set.



\*Important: If the remote control POWER, ACTION, CH▲/▼, INDEX, NUMBERED keys, INPUT, TAPE POSITION, or ADD/HLT button does not work when pressed, press the VCR button on the remote and try the button again.

## Weak Signal Display ON/OFF Feature

When "ON" is selected, picture is displayed even when broadcast signal is weak or nonexistent.

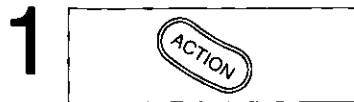

**Display menu.**  
Press ACTION.

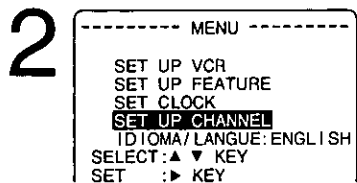

**Display SET UP CHANNEL.**

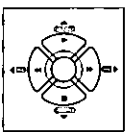

1) Press ▲▼ to select.  
2) Press ► to display.

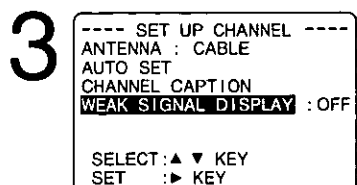

**Set ON or OFF.**

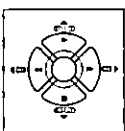

1) Press ▲▼ to select.  
2) Press ► to set.

- ON --> Picture is displayed regardless of signal condition, and may not always be clearly visible.
- OFF --> Screen turns solid blue when signal is absent or weak.
- If VCR is connected to equipment which has blue back feature, selecting ON will have no effect on the other equipment.

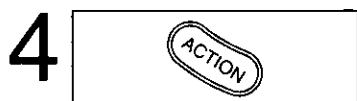

**Return to normal screen.**  
Press ACTION twice.

## Auto Shut-Off Feature

When "ON" is selected, VCR shuts itself off when playback of a blank portion of tape continues or no signal (except when LINE is selected) is detected for over 5 minutes.

**a** Repeat step "a" and "b" on page 24 to display SET UP VCR.

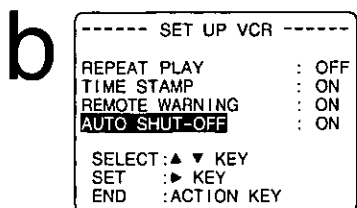

**Set ON or OFF.**

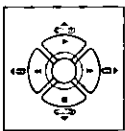

1) Press ▲▼ to select.  
2) Press ► to set.

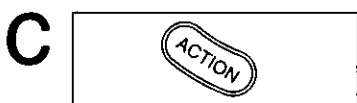

**Return to normal screen.**  
Press ACTION twice.

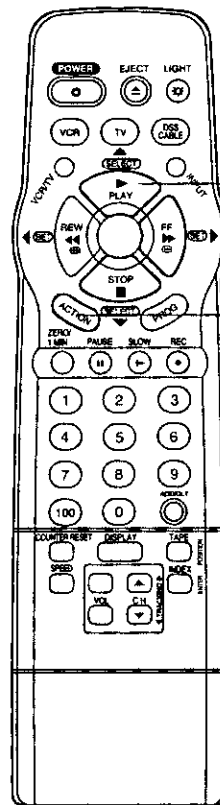

**2** SELECT/SET  
**3** ▲:PLAY  
▼:STOP  
►:FF  
**1** ACTION  
**4** C

Special VCR Features

# Reset Language, Channels, Clock

1

```

----- MENU -----
SET UP VCR
SET UP FEATURE
SET CLOCK
SET UP CHANNEL
IDIOMA/LANGUE: ENGLISH
SELECT: ▲ ▼ KEY
SET : ► KEY
END : ACTION KEY
    
```



**Display menu.**  
Press ACTION.\*

## 2 Language

1) Press ▲▼ to highlight language item.

```

----- MENU -----
SET UP VCR
SET UP FEATURE
SET CLOCK
SET UP CHANNEL
IDIOMA/LANGUE: ENGLISH
SELECT: ▲ ▼ KEY
SET : ► KEY
END : ACTION KEY
    
```

2) Press ► repeatedly.

```

----- MENU -----
SET UP VCR
SET UP FEATURE
SET CLOCK
SET UP CHANNEL
IDIOMA/LANGUE: ENGLISH
SELECT: ▲ ▼ KEY
SET : ► KEY
END : ACTION KEY
    
```

For English

```

----- MENU -----
PREPARAR VCR
FIJACION DE FUNCIONES
FIJAR RELOJ
FIJAR CANAL
LANGUE/LANGUAGE: ESPAÑOL
ELEGIR: ▲ ▼
FIJAR : ►
TERMINAR: ACTION
    
```

For Spanish

```

----- MENU -----
REGLAGE MAGNETOSCOPE
REGLAGE MAGNETO SUPPLEM
REGLAGE HORLOGE
REGLAGE CANAL
LANGUE/IDIOMA: FRANÇAIS
SEL. : ▲ ▼
REGLER: ►
FIN : ACTION
    
```

For French

## Channels

1) Press ▲▼ to select SET UP CHANNEL.

```

----- MENU -----
SET UP VCR
SET UP FEATURE
SET CLOCK
SET UP CHANNEL
IDIOMA/LANGUE: ENGLISH
SELECT: ▲ ▼ KEY
SET : ► KEY
END : ACTION KEY
    
```

2) Press ►.

```

----- SET UP CHANNEL -----
ANTENNA : CABLE
AUTO SET
CHANNEL CAPTION
WEAK SIGNAL DISPLAY : OFF

SELECT: ▲ ▼ KEY
SET : ► KEY
END : ACTION KEY
    
```

3) Press ▲▼ to select "ANTENNA," then press ► to set your antenna system (TV or CABLE).

4) Press ▲▼ to select "AUTO SET," then press ►.

- If you use a cable box, set it to the PBS channel in your time zone.

```

CHANNEL/CLOCK AUTO SET

CONNECT ANTENNA CABLE
AND IF YOU USE A CABLE
BOX, TUNE IT TO YOUR
LOCAL PBS CH THEN...

PLEASE PUSH CH UP KEY
    
```

(This screen appears only when auto clock is set.)

5) Press CH ▲.

- Clock Auto Set will be performed when channels are replaced in memory.

## Clock

1) Press ▲▼ to select SET CLOCK.

```

----- MENU -----
SET UP VCR
SET UP FEATURE
SET CLOCK
SET UP CHANNEL
IDIOMA/LANGUE: ENGLISH
SELECT: ▲ ▼ KEY
SET : ► KEY
END : ACTION KEY
    
```

2) Press ►.

```

----- SET CLOCK -----
AUTO CLOCK SET
MANUAL
TIME ZONE ADJUST : 0

SELECT: ▲ ▼ KEY
SET : ► KEY
END : ACTION KEY
    
```

("TIME ZONE ADJUST" appears only when clock is set automatically.)

3) Press ▲▼ to select MANUAL and press ►.

- For Auto Clock Set, select "AUTO CLOCK SET," then press CH ▲.

```

----- SET CLOCK -----
1/ 4/2000 TUE 12:00PM
DST: ON \

SELECT HOUR

SELECT: ▲ ▼ KEY
SET : ◀ ▶ KEY
END : ACTION KEY
    
```

4) Press ▲▼ and ◀▶ to select and set the date, time, and DST (Daylight Saving Time).

5) Press ACTION twice to start the clock and exit this mode.

**Important:** If the remote control POWER, ACTION, CH▲/▼, INDEX, NUMBERED keys, INPUT, TAPE POSITION, or ADD/DLT button does not work when pressed, press the VCR button on the remote and try the button again.

## Add or Delete a Channel

**To add channel:**

Select channel with NUMBERED keys and press ADD/DLT.

**To delete channel:**

Select channel with CH ▲/▼ or NUMBERED keys and press ADD/DLT.

CHANNEL 08 ADDED

CHANNEL 08 DELETED

## Time Zone Adjust

(When Auto Clock is set only.)

- 1) Press ▲▼ to select SET CLOCK.

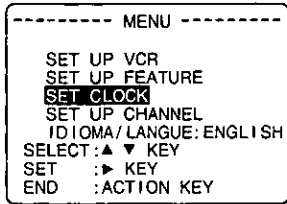

- 2) Press ►.

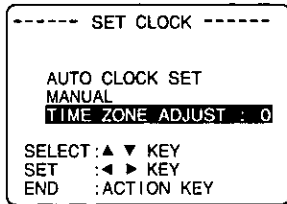

- 3) Press ▲▼ to select TIME ZONE ADJUST and press ◀ or ▶ to subtract or add hour(s) as necessary.

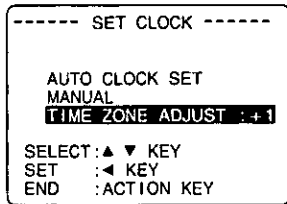

- 4) Press ACTION twice.

- 5) Press POWER off to perform AUTO CLOCK SET.

- TIME ZONE ADJUST returns to "0" if clock is set manually.

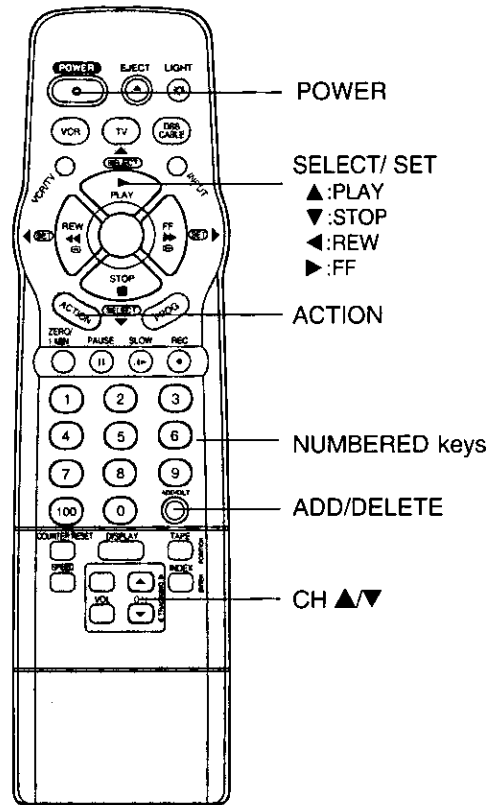

## Using ▲▼◀▶ keys

You can also operate the menu screen using VCR buttons.

If you use VCR buttons, press CH ▲ and CH ▼ together to display the menu screen.

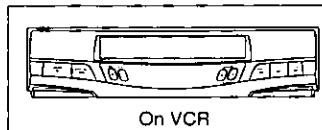
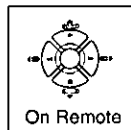

▲ : PLAY  
▼ : STOP  
◀ : REW  
▶ : FF

When menu screens are displayed, PLAY, STOP, REWIND, and FF buttons function as ▲▼◀▶ only.

# VCR & Cassette Information

## Reset All VCR Memory Functions

Use when moving VCR to new location, or if a mistake was made in the One Time VCR Setup section.

- Make sure a tape is not inserted in the VCR.

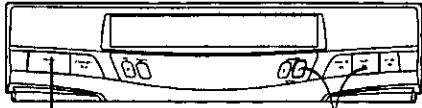

**1** Turn VCR Power on.

**2** Press and hold both **PLAY** and **CHANNEL ▲** on the VCR for more than 5 seconds.  
 • The power will shut off.

**3** Do "One Time VCR Setup" steps on page 6.

## Prevent Accidental Tape Erasure

Break off the tab.

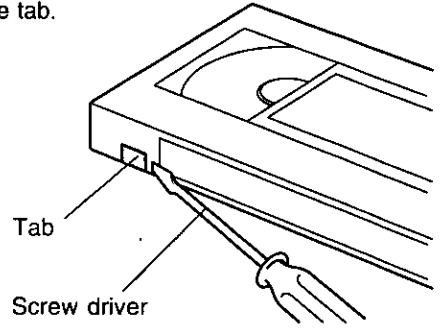

To record again

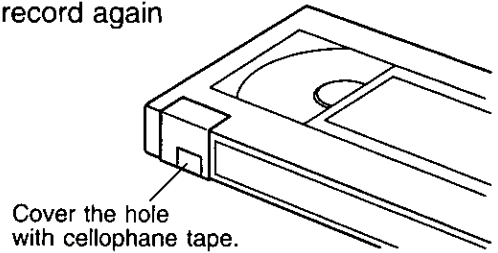

## DST (Daylight Saving Time)

VCR auto adjusts clock for DST. (Page 7.)

**Spring (First Sunday in April)**

DST:ON --> sets clock ahead one hour.

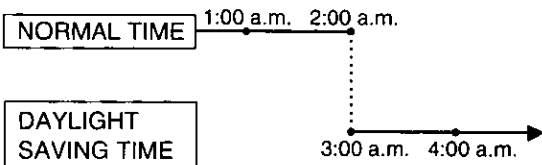

**Autumn (Last Sunday in October)**

DST:ON --> Turns clock back one hour.

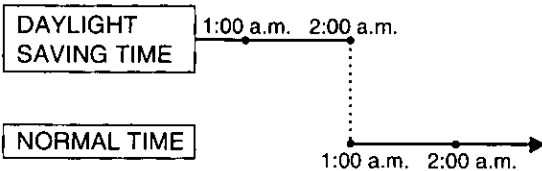

- If your area does not observe Daylight Saving Time, select DST:OFF.
- Keep these time changes in mind when programming the VCR for timer recordings.

## Record/Playback Time

Only use tapes with the **VHS** mark in this unit.

Tape Speed Setting	Type of Video Cassette		
	T60	T120	T160
SP (Standard Play)	1 Hour	2 Hours	2 Hours 40 Minutes
LP (Long Play)	2 Hours	4 Hours	5 Hours 20 Minutes
SLP (Super Long Play)	3 Hours	6 Hours	8 Hours

## Head Cleaning

Playing older or damaged tapes may eventually cause video heads to become clogged.

### Video Head Clog Sensor

During playback this screen appears if clogging is detected. To remove screen, press PLAY on the remote or VCR.

VIDEO HEADS MAY  
NEED CLEANING  
PLEASE INSERT HEAD  
CLEANING CASSETTE  
OR REFER TO MANUAL

END:PLAY KEY

- Use "dry" type head cleaning cassette only. (Part No. NV-TCL30PT is recommended.)

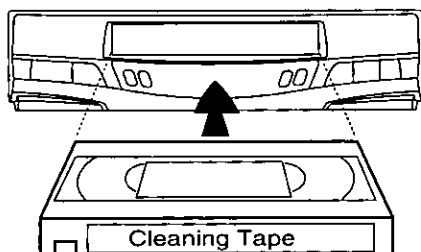

- Follow cleaning tape instructions carefully. Excessive use of tape can shorten head life.
- If head clog symptoms persist, contact your nearest Factory Service Center or authorized Service Center.

## Specifications

<b>Power Source:</b>	120V AC, 60 Hz
<b>Power Consumption:</b>	<u>Power On</u> Approx. 18 watts <u>Power Off</u> Approx. 3.3 watts
<b>Video Signal:</b>	EIA Standard NTSC color
<b>Video Recording System:</b>	4 rotary heads helical scanning system
<b>Audio Track:</b>	1 track (Normal)
<b>Tuner:</b>	
<b>Broadcast Channels:</b>	VHF 2~13, UHF 14~69
<b>CABLE Channels:</b>	Midband A through I (14~22) Superband J through W (23~36) Hyperband AA~EEE (37~64) Lowband A-5~A-1 (95~99) Special CABLE channel 5A (01) Ultraband 65~94, 100~125
<b>Operating Temperature:</b>	41°F~104°F (5°C~40°C)
<b>Operating Humidity:</b>	10%~75%
<b>Weight:</b>	7.7 lbs. (3.5 kg)
<b>Dimensions:</b>	14-15/16" (W) x 3-2/3" (H) x 12-3/16" (D) 380 (W) x 93 (H) x 310 (D) mm

Note: Designs and specifications are subject to change without notice.

## Build-in Head Cleaner

A clean video head helps produce a clear picture. So, we have equipped your VCR with a built-in, non chemical head cleaning system that helps prevent clogging of the video heads. Cleaning is performed each time you load or unload a video cassette.

- This feature is preventative only. If your video heads are seriously clogged, consider the use of a chemical nonabrasive head cleaning kit or take your VCR to a Service Center.

## Cleaning the VCR

Use a soft cloth or dusting attachment of your vacuum cleaner to dust your VCR. Remove dust from the ventilation holes on the back sides and bottom of the cabinet.

Plastic surfaces are easily scratched and can be marred by alcohol and various solvents. Avoid excessive use of oil-based furniture polishes since the materials used in the cabinet will accumulate more dust. We recommend using a nonabrasive, antistatic cleaner and polisher.

## Features for a Quality Picture

### Digital Auto Picture

Automatically controls the video output signal for less noise depending on the tape condition.

### Digital Auto Tracking

Continuously analyzes the signal and adjusts for optimum picture quality.

### Manual Tracking Control (to reduce picture noise)

Use during Playback and Slow Motion mode to reduce picture noise. To return to Auto Tracking, press POWER off, then on again.

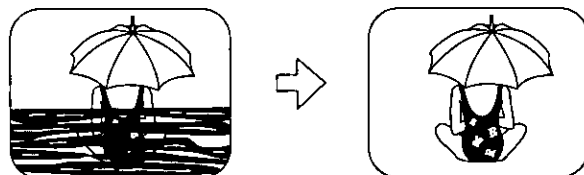

### V-Lock Control (to reduce picture jitter)

In Still mode, CH (TRACKING) ▲▼ operate as a V-Lock control.

# On-Screen Displays (OSD)

## Function & Channel Display

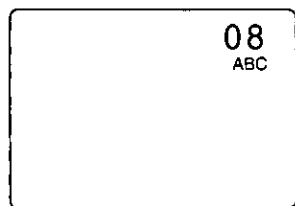

When a function button is pressed, e.g. PLAY, or you change channels, a 4 second display appears first in large and then small characters. (Some Station names may also appear if Channel Caption is set. See page 20, 21.)

## Blank Tape/ No Video Signal Indication

Whenever a blank section of a tape comes up in Play mode, or when the selected channel has no broadcast signal with the Weak Signal Display Feature (page 25) set to OFF, the TV screen will turn solid blue.

## VCR Status & Clock Display

To display or remove the overlay.

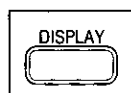

Press DISPLAY.

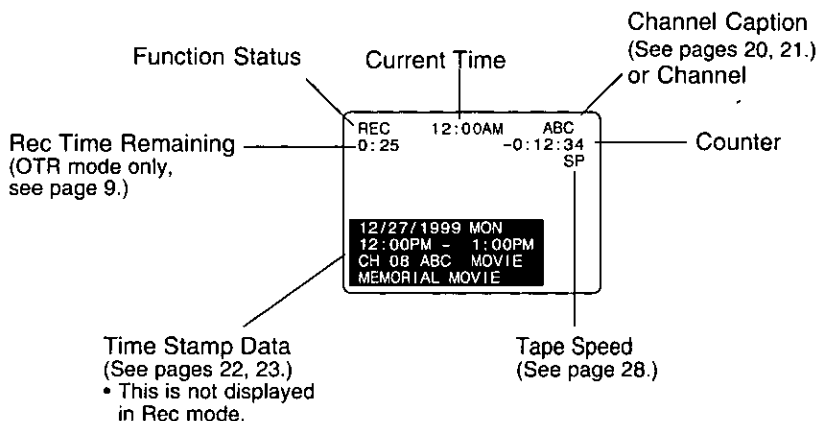

## Warning and Instruction Displays

These displays will alert you of a missed operation or provide further instructions.

OSD	Caution	Pg	OSD	Caution	Pg
NO CH FOUND PLEASE CHECK ANTENNA CABLE CONNECTION THEN PUSH VCR CH UP KEY AGAIN	If no active channels are found for CHANNEL MEMORY...	6	TO CANCEL TIMER REC PUSH POWER THEN STOP KEY	If you press POWER or STOP during a Timer Recording... (visible in VCR mode only)	13
PLEASE SET CLOCK BEFORE PROGRAMMING	If you attempt to set or review a Timer Recording and the Clock is not set...	6	VIDEO HEADS MAY NEED CLEANING PLEASE INSERT HEAD CLEANING CASSETTE OR REFER TO MANUAL END: PLAY KEY	If head cleaning becomes necessary while playing back a tape...	29
TURN VCR OFF FOR TIMER RECORDING	After a Timer Program has been set...	13	VCR LOCK ACTIVATED	If you press a function button other than STOP/EJECT or POWER while the VCR is in VCR Lock mode...	24
CHECK CASSETTE RECORD TAB	If you press REC on the remote control or VCR, and a cassette is inserted with no record tab...	28	REMOTE CONTROL IS SET TO CABLE/DSS MODE  USE VCR : VCR KEY USE TV : TV KEY	If you press any invalid keys on the remote while in CABLE/DSS mode...	14 15
NO CASSETTE PLEASE INSERT A CASSETTE	If you press PLAY, FF, REW, or REC on the remote control or VCR without a cassette inserted...	8 9	REMOTE CONTROL IS SET TO TV MODE  USE VCR : VCR KEY USE CABLE/DSS : CABLE/DSS	If you press any invalid keys on the remote while in TV mode...	14 15

# Before Requesting Service

Check the following points once again if you are having trouble with your VCR.

<b>Power</b>	<b>Correction</b>
No power...	<ul style="list-style-type: none"> <li>• Completely insert Power Plug into an AC outlet.</li> <li>• Set POWER button to ON.</li> <li>• Make sure power source is active.</li> </ul>
<b>Recording &amp; Playback</b>	<b>Correction</b>
TV program cannot be recorded...	<ul style="list-style-type: none"> <li>• Check connections between VCR, external antenna, and TV.</li> <li>• Check hook up selection. (P.4-5)</li> <li>• Make sure your antenna system (CABLE or TV) is correctly set. (Channels [P.26])</li> <li>• Make sure cassette record tab is intact. (P.28)</li> </ul>
Timer recording cannot be performed...	<ul style="list-style-type: none"> <li>• Check clock is set to current time and date.</li> <li>• Make sure Cable/DSS box (if used) is left on and tuned to channel to be recorded.</li> <li>• Set recording start/stop times correctly. (P.12)</li> <li>• Make sure POWER button is set to OFF. (P.13)</li> <li>• Timer recording may not be performed or continued if a power interruption of more than 1 minute occurs before or during, a Timer Recording, even after power is restored.</li> </ul>
There is no playback picture, or the playback picture is noisy or contains streaks...	<ul style="list-style-type: none"> <li>• Select channel 3 or 4 on TV to match Channel 3/4 switch on rear panel of VCR (P.4) or select LINE.</li> <li>• Set VCR/TV selector to "VCR."</li> <li>• Adjust TRACKING control in either direction. (P.29)</li> <li>• Try Head Cleaning. (P.29)</li> </ul>
Special effects playback, picture may contain some vertical jitter when using a TV with an Automatic Vertical Hold Control...	<ul style="list-style-type: none"> <li>• Set TV's Vertical Hold Control to "MANUAL" then adjust.</li> </ul>
VCR cannot be controlled...	<ul style="list-style-type: none"> <li>• Make sure VCR LOCK is set to off. (P.24)</li> <li>• Make sure remote is in proper mode.</li> <li>• Make sure unit is not in a Timer Record operation.</li> </ul>
<b>Remote Control</b>	<b>Correction</b>
VCR cannot be remote controlled...	<ul style="list-style-type: none"> <li>• Aim Remote Control directly at remote sensor on VCR. (P.36)</li> <li>• Avoid any object blocking signal path.</li> <li>• Inspect remote batteries. (P.4)</li> <li>• Make sure VCR LOCK is set to off. (P.24)</li> <li>• Exposing VCR remote sensor to direct fluorescent or outdoor light may cause signal interference.</li> </ul>
ACTION and PROG buttons cannot be used...	<ul style="list-style-type: none"> <li>• Press VCR button for VCR mode. (P.14)</li> <li>• Check Batteries.</li> </ul>
<b>Miscellaneous</b>	<b>Correction</b>
Programs cannot be viewed on TV...	<ul style="list-style-type: none"> <li>• Set VCR/TV selector to "TV." (P.9)</li> <li>• Make sure proper signal source is selected.</li> </ul>
Video cassette cannot be inserted...	<ul style="list-style-type: none"> <li>• Insert the cassette with window side up; record tab facing you.</li> <li>• Insure no other tape is inside unit.</li> </ul>
Video cassette cannot be removed...	<ul style="list-style-type: none"> <li>• Completely insert Power Plug into AC outlet.</li> </ul>
Video cassette ejects when a recording is started or the power is turned off for timer recording...	<ul style="list-style-type: none"> <li>• Make sure cassette rec tab is intact. (P.28)</li> </ul>
In Stop mode, the motor (CYLINDER) continues to rotate...	<ul style="list-style-type: none"> <li>• To enable Quick play mechanism, the cylinder will rotate for about 5 minutes. This reduces response time from Stop to Play mode and from Play to Rewind Search mode.</li> </ul>
The top of the playback picture waves back and forth excessively...	<ul style="list-style-type: none"> <li>• Because VCR playback signal is not as stable as off-the-air TV signal, top of TV screen may be bent or unstable during playback. Slowly turn TV horizontal Hold control to correct. If your TV has no horizontal Hold control or adjusting control is ineffective, contact your nearest TV service center.</li> </ul>

# Warranty

Panasonic Consumer Electronics Company,  
Division of Matsushita Electric Corporation  
of America,  
One Panasonic Way  
Secaucus, New Jersey 07094

Panasonic Sales Company,  
Division of Matsushita Electric of Puerto Rico, Inc.  
AVE. 65 de Infantería, Km. 9.5  
San Gabriel Industrial Park  
Carolina, Puerto Rico 00985

## PANASONIC Video Products Limited Warranty

Panasonic Consumer Electronics Company or Panasonic Sales Company (collectively referred to as "the Warrantor") will repair this product with new or refurbished parts, free of charge, in the USA or Puerto Rico, in the event of a defect in materials or workmanship as follows (all time periods commence from the date of the original purchase):

<u>PRODUCT</u>	<u>PARTS</u>	<u>LABOR</u>
CAMCORDER	ONE (1) YEAR, EXCEPT CCD IMAGE SENSOR CCD IMAGE SENSOR - SIX (6) MONTHS	NINETY (90) DAYS NINETY (90) DAYS
VCR	ONE (1) YEAR	NINETY (90) DAYS
A/V MIXER	ONE (1) YEAR	NINETY (90) DAYS
MONITOR-VCR	ONE (1) YEAR, EXCEPT CRT CRT - TWO (2) YEARS	NINETY (90) DAYS CRT - NINETY (90) DAYS CUSTOMER PAYS ALL LABOR CHARGES AFTER 90 DAYS



**Monitor-VCR In-home or carry-in Service: 22" (diagonal) CRT / LCD and Larger**  
**Monitor-VCR Carry-in Service: 21" (diagonal) CRT / LCD and smaller**

Batteries (if included) - New rechargeable batteries in exchange for defective rechargeable batteries for ten (10) days. Non-rechargeable batteries are not warranted.

Tape (if included) - New video cassette tape in exchange for a defective video cassette tape for five (5) days.

In-home, carry-in or mail-in service, as applicable, in the USA can be obtained during the warranty period by contacting a Panasonic Services Company (PASC) Factory Servicenter listed in the Service Directory. Or call toll free 1-800-211-PANA (7262), to locate an authorized PASC Servicenter. Carry-in or mail-in service in Puerto Rico can be obtained during the warranty period by calling the Panasonic Sales Company telephone number listed in the Servicenter Directory.

This warranty is extended only to the original purchaser. A purchase receipt or other proof of the date of the original purchase is required before warranty service is rendered.

- This warranty only covers failures due to defects in materials and workmanship which occur during normal use and does not cover normal maintenance, including, but not limited to, video and audio head cleaning. The warranty does not cover damage which occurs in shipment, or failures which are caused by products not supplied by the warrantor, or failures which result from accident, misuse, abuse, neglect, mishandling, misapplication, alteration, modification, faulty installation, set-up adjustments, improper antenna, inadequate signal pickup, maladjustment of consumer controls, improper operation, power line surge, improper voltage supply, lightning damage, commercial use such as hotel, office, restaurant, or other business or rental use of the product, or service by anyone other than a PASC Factory Servicenter or a PASC authorized Servicenter, or damage that is attributable to acts of God.

**LIMITS AND EXCLUSIONS**

There are no express warranties except as listed above.

THE WARRANTOR SHALL NOT BE LIABLE FOR INCIDENTAL OR CONSEQUENTIAL DAMAGES (INCLUDING, WITHOUT LIMITATION, DAMAGE TO TAPES) RESULTING FROM THE USE OF THIS PRODUCTS, OR ARISING OUT OF ANY BREACH OF THE WARRANTY. ALL EXPRESS AND IMPLIED WARRANTIES, INCLUDING THE WARRANTIES OF MERCHANTABILITY AND FITNESS FOR PARTICULAR PURPOSE, ARE LIMITED TO THE APPLICABLE WARRANTY PERIOD SET FORTH ABOVE. Some states do not allow the exclusion or limitation of incidental or consequential damages, or limitations on how long an implied warranty lasts, so the above exclusions or limitations may not apply to you.

This warranty gives you specific legal rights and you may also have other rights which vary from state to state.

If a problem with this product develops during or after the warranty period, you may contact your dealer or Servicenter. If the problem is not handled to your satisfaction, then write to the Customer Satisfaction Center at the Panasonic Consumer Electronics Company address above.

SERVICE CALLS WHICH DO NOT INVOLVE DEFECTIVE MATERIALS OR WORKMANSHIP AS DETERMINED BY THE WARRANTOR, IN ITS SOLE DISCRETION, ARE NOT COVERED. COSTS OF SUCH SERVICE CALLS ARE THE RESPONSIBILITY OF THE PURCHASER.  
warvid 10/20/97

**Thank you for your purchase.**  
**For service of this Panasonic product, please contact your local Sears Service Center.**  
**To locate the closest Sears Service Center, call 1-800-488-1222.**

Warranty

## Para ajustar el idioma, canal y reloj

- 1 Encienda el televisor y la videgrabadora.**  
Presione POWER.
- 2 Sintonice el televisor al canal de salida de la videgrabadora.**  
(el mismo canal que ha ajustado en la parte trasera de la videgrabadora; canal 3 o 4).
  - Sintonice siempre el televisor en este canal para obtener la pantalla de videgrabadora.
  - Si esta usando los terminales de audio/ video para su conexión, ajuste el televisor al modo de entrada de video.

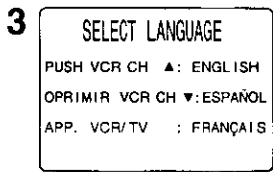

**Seleccione el lenguaje.**  
Oprimir CH ▲ para elegir el idioma de la pantalla en inglés.

Oprimir CH ▼ para elegir el idioma de la pantalla en español.

Oprimir VCR/ TV para elegir el idioma de la pantalla en francés.

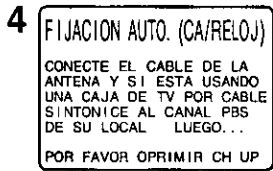

**Comience el ajuste automático de canales y el ajuste automático del reloj.**

Presione CH ▲.

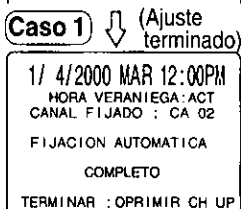
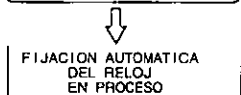

Presione CH ▲ para salir.

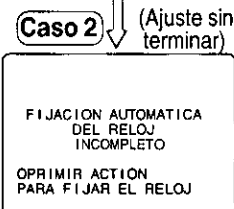

### **Caso 2** El ajuste del reloj es incompleto.

#### Ajuste el reloj manualmente.

- 1) Presione ACTION.
- 2) Presione ▲▼ para seleccionar el mes.
- 3) Presione ► para ajustar.
  - De la misma manera, ajuste el día, el año, la hora y la hora de ahorro de energía (VERANO).
  - Para hacer correcciones, presione repetidamente ◀▶ para moverse hasta el error, luego corríjalo.
- 4) Presione ACTION. (El reloj se activa.)
  - Para salir de este modo, pulse la tecla ACTION nuevamente.

## Ajustar de nuevo el reloj

- 1** Presione ACTION para exhiba el menú.
- PREPARAR VCR  
FIJACION DE FUNCIONES  
FIJAR RELOJ  
FIJAR CANAL  
LANGUE/ LANGUAGE: ESPAÑOL  
ELEGIR: ▲▼  
FIJAR : ►  
TERMINAR: ACTION

Presione ▲▼ para seleccionar "FIJAR RELOJ" y luego presione ►.
- FIJAR RELOJ  
FIJACION AUTOMATICA  
MANUAL  
AJUSTE ZONA HORA : 0  
ELEGIR: ▲▼  
FIJAR : ►  
TERMINAR: ACTION

Presione ▲▼ para seleccionar "MANUAL" y luego presione ►.
- FIJAR RELOJ  
1/ 4/2000 MAR 12:00PM  
VERANO: ACT/ I  
ELEGIR HORA  
ELEGIR: ▲▼  
FIJAR : ◀▶  
TERMINAR: ACTION

Presione ▲▼ y ◀▶ para seleccionar y ajustar la hora y la fecha.
- 5** Presione ACTION dos veces para que el reloj comience a funcionar y salir desde este modo.

## Operaciones básicas para la reproducción

- 1 Inserte un casete.**
  - La videgrabadora se enciende automáticamente.
- 2 Presione PLAY.**
  - La reproducción comienza si el casete no tiene la lengüeta para prevención de grabación.
  - Para encontrar una escena en particular  
Búsqueda hacia adelante ---> Presione FF.  
Búsqueda hacia atrás ---> Presione REW.
  - Para ver en cámara lenta ---> Presione SLOW.
  - Para ver una imagen fija (congelada) ---> Presione PAUSE.
  - Para ver imágenes cuadro a cuadro ---> Presione SLOW en el modo de imagen fija.
  - Para parar ---> Presione STOP.
  - Para rebobinar la cinta ---> Presione REW.
  - Para expulsar la cinta ---> Presione STOP/ EJECT en el videgrabadora.

## Operaciones básicas para la grabación

1

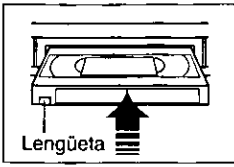

Inserte un casete.

- La videograbadora se enciende automáticamente.

## 2 Seleccione el canal.

Presione CH ▲/▼ o las teclas numéricas correspondiente.

## 3 Seleccione la velocidad de grabación.

Presione SPEED.

- SP = Reproducción estándar,
- LP = Larga duración,
- SLP = Superlarga duración.

## 4 Comience la grabación.

Presione REC.

- Presione PAUSE para hacer una pausa en la grabación en progreso.

■ Para parar ---> Presione STOP.

■ Grabación de un toque

Presione REC repetidamente para ajustar la hora de grabación (30 min - 4 horas).

- La videograbadora termina la grabación a una hora programada.

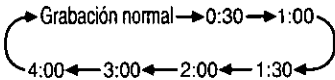

## Programación fácil para la grabación con temporizador

### 1 Exhiba el menú.

Presione ACTION.

Exhiba la pantalla de la programación.

- Si ya existe un programa en la memoria, presione ▲▼ y ► para seleccionar un número de programa sin usar.

2

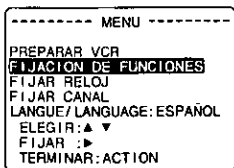

Exhiba "FIJACION DE FUNCIONES."

- 1) Presione ▲▼ para seleccionar.
- 2) Presione ► para exhibir.

3

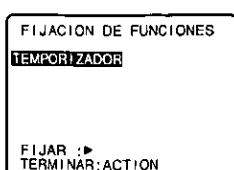

Exhiba "TEMPORIZADOR."

- 1) Presione ► para exhibir.
- Si ya existe un programa en la memoria, presione ▲▼ y ► para seleccionar un número de programa sin usar.

4

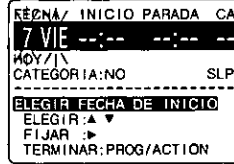

Ajuste la fecha de grabación.

- 1) Presione ▲▼ para seleccionar.
- 2) Presione ► o ◀ para ajustar.

- 1-31 = Grabación única
- DIARIO = a la misma hora de lunes a viernes
- SEMANA = a la misma hora una vez a la semana

Ejemplo

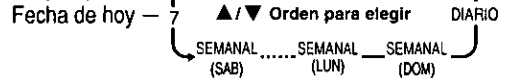

Repita el paso 3 para ajustar: hora de comienzo, hora de parada, canal (o LINEA para una fuente exterior), categoría\*, velocidad (SP, LP, SLP).

\*Categoría

NO, DEPORTE, CINE, COMEDIA, MUSICA, DRAMA

5



Haga las anotaciones necesarias.

- Si no fueran necesarias, vaya al paso 6.

- 1) Presione ▲ para hacerlas.
- 2) Presione ▲▼ para seleccionar.
- 3) Presione ► para ajustar.
- 4) Presione PROG (o ACTION) para salir.

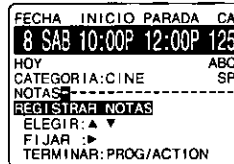

6

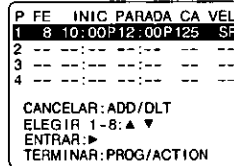

Termine el programa.

- 1) Presione PROG (o ACTION).

Para introducir más programas.

Presione ▲▼ y ► para seleccionar y ajustar el número de programa en blanco. Luego repita los pasos 4 y 5.

- 2) Presione PROG (o ACTION) para salir.

7



Grabación con temporizador.

Presione POWER para apagar.

Pantalla multifuncional

- Si la fuente de la grabación es una caja de TV por cable, asegúrese de que la caja de TV por cable esté encendida y esté sintonizada al canal que desea grabar.

# Location of Controls

## Remote control Buttons

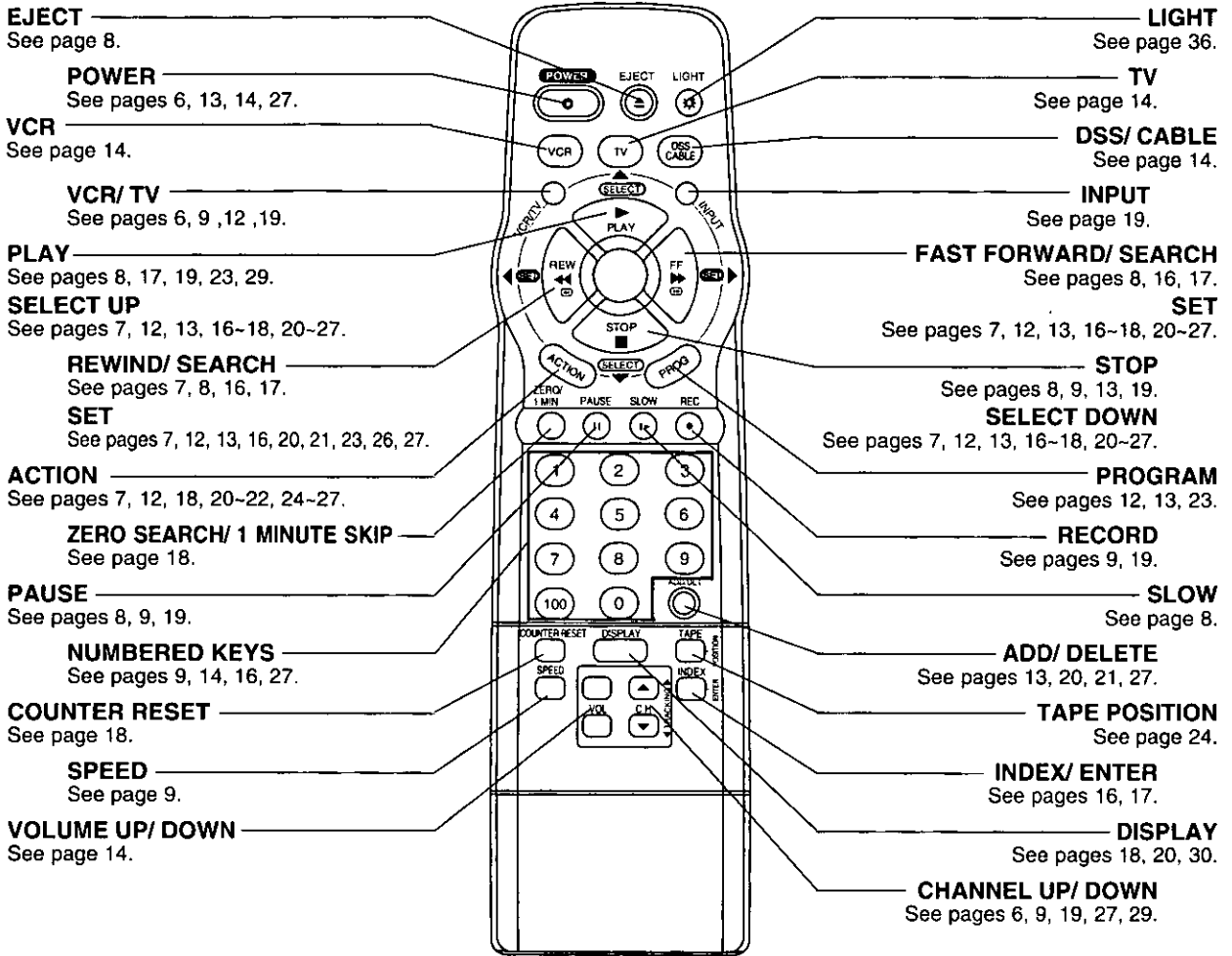

## Light Tower Universal Remote Control

**Light button:** When the LIGHT button is pressed, the buttons which can be activated in the selected mode will light and the selected mode button (TV/VCR or CABLE DSS) will flash for 5 seconds. If no buttons are pressed within 5 seconds, the light will turn off in order to conserve battery power. Also while holding down the buttons, the selected mode button will flash so you will be able to see, in the dark, which mode has been selected.

**EJECT button:** When EJECT is pressed, the tape is ejected from Cassette Compartment.  
If EJECT is pressed during recording, the VCR will not respond to the command.

## Front View of the VCR

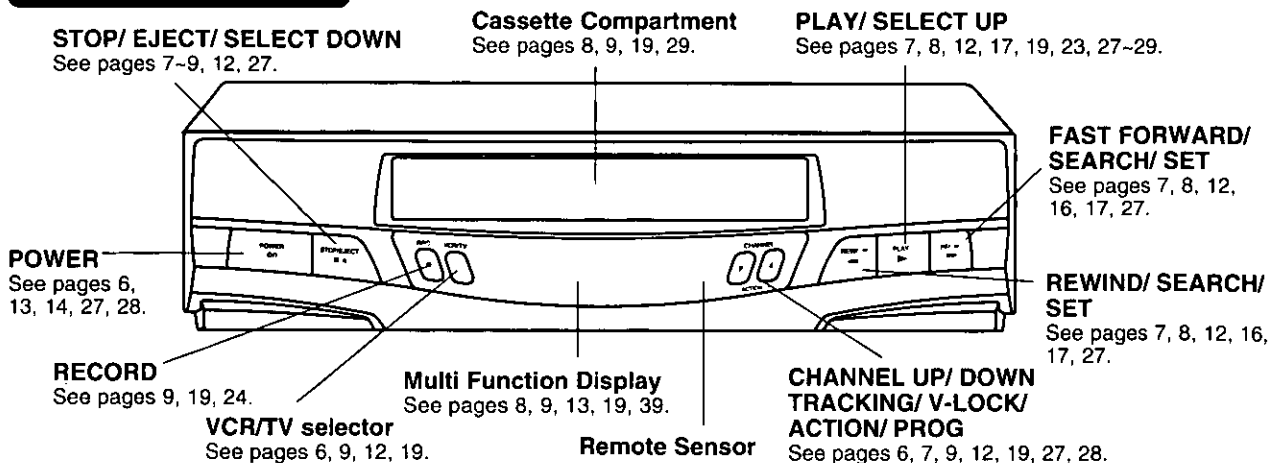

## Multi Function Display

### VCR Indicator

Lights when the VCR/TV selector is set to VCR.

### Power Indicator

Lights when power is on.

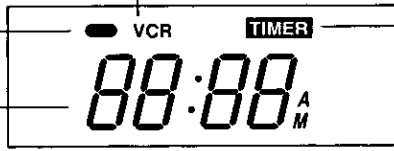

### Clock/ Status/ Channel/ Speed Display

Displays the current time. Briefly displays VCR status when a function button is pressed. Briefly displays the channel number, or "L" when a channel or line input is selected. Briefly displays the recording speed when SPEED is pressed.

### Timer Indicator

Lights when the VCR is set for a Timer Recording, or when a length is set for a normal recording (OTR). Flashes when a Timer Recording is set, but a tape has not been inserted into the VCR.

## Rear View of the VCR

### AC Power Plug

While plugged into an AC outlet, the VCR consumes 3.3 W of electrical power in OFF condition.

### Video Input Connector

See page 19.

### Video Output Connector

See pages 11, 19, 20.

### VHF/UHF Antenna Input Terminal

See pages 4, 10, 11, 20.

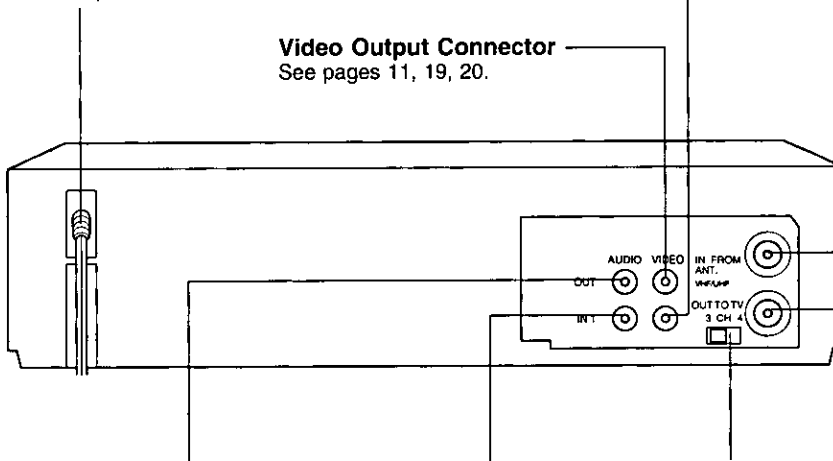

### VHF/UHF Antenna Output Terminal

See pages 4, 10, 11, 19, 20.

### Audio Output Connector

See page 19.

### Channel 3/4 Switch

See pages 4, 6.

### Audio Input Connector

See page 19.





# Quick Use Guide

## Playback a Tape

**1** Make all connections (page 4).

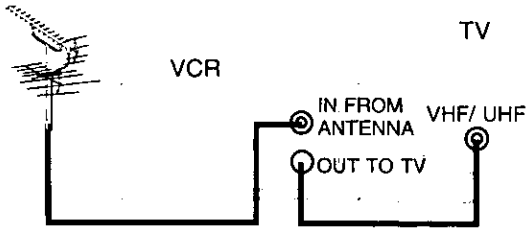

**2** Set VCR Channel on VCR Rear Panel.

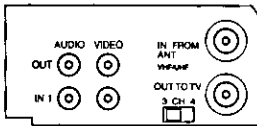

Slide the VCR Channel selector switch to the channel number not used by local broadcast companies (CH3 or 4).

Tune your TV to the channel selected above (3 or 4) whenever you want to see the picture from the VCR on your TV screen.

**3** Play your Tape.



Insert a tape



Press **PLAY**  
(Start playback)

## Record on a Tape

**1** Make all connections (page 4).

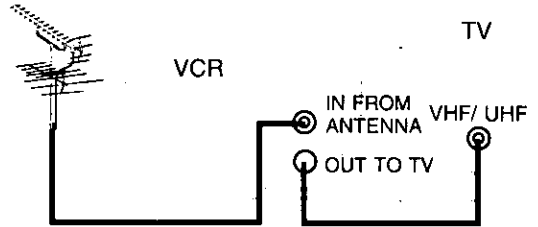

**2** Set VCR Channel on VCR Rear Panel.

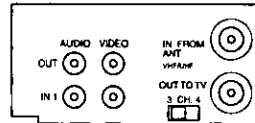

Slide the VCR Channel selector switch to the channel number not used by local broadcast companies (CH3 or 4).

Tune your TV to the channel selected above (3 or 4) whenever you want to see the picture from the VCR on your TV screen.

**3** Do "One Time VCR Setup" on page 6.

In order for the VCR to properly interface with your equipment, some setup is necessary.

**4** Record on a Tape.



Insert a tape  
with Record Tab

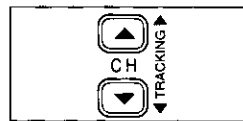

Press **CH Up/Down**.  
(Select Channel)

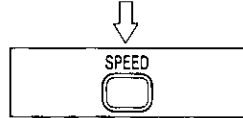

Press **SPEED**.  
(Select speed)

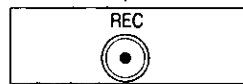

Press **REC**.  
(Start Recording)

Panasonic Consumer Electronics  
Company, Division of Matsushita  
Electric Corporation of America  
One Panasonic Way Secaucus,  
New Jersey 07094

Panasonic Sales Company,  
Division of Matsushita Electric of  
Puerto Rico, Inc. ("PSC")  
Ave. 65 de Infantería, Km. 9.5  
San Gabriel Industrial Park, Carolina,  
Puerto Rico 00985

Printed in Japan  
VQTS3557A

